

**NPS ARCHIVE**  
**1998.06**  
**O'NEAL, D.**

DUDLEY KNOX LIBRARY  
NAVAL POSTGRADUATE SCHOOL  
MONTEREY CA 93943-5101







# NAVAL POSTGRADUATE SCHOOL MONTEREY, CALIFORNIA



## THESIS

COMPARISON OF THE UNDERWATER AMBIENT  
NOISE MEASURED IN THREE LARGE EXHIBITS  
AT THE MONTEREY BAY AQUARIUM AND IN  
THE INNER MONTEREY BAY

by

Daniel Matthew O'Neal

June 1998

Thesis Advisor:

Steven R. Baker

Approved for public release; distribution is unlimited.



# REPORT DOCUMENTATION PAGE

Form Approved OMB No. 0704-0188

Public reporting burden for this collection of information is estimated to average 1 hour per response, including the time for reviewing instruction, searching existing data sources, gathering and maintaining the data needed, and completing and reviewing the collection of information. Send comments regarding this burden estimate or any other aspect of this collection of information, including suggestions for reducing this burden, to Washington Headquarters Services, Directorate for Information Operations and Reports, 1215 Jefferson Davis Highway, Suite 1204, Arlington, VA 22202-4302, and to the Office of Management and Budget, Paperwork Reduction Project (0704-0188) Washington DC 20503.

1. AGENCY USE ONLY <i>(Leave blank)</i>	2. REPORT DATE June 1998	3. REPORT TYPE AND DATES COVERED Master's Thesis	
4. TITLE AND SUBTITLE <b>COMPARISON OF THE UNDERWATER AMBIENT NOISE MEASURED IN THREE LARGE EXHIBITS AT THE MONTEREY BAY AQUARIUM AND IN THE INNER MONTEREY BAY</b>			5. FUNDING NUMBERS
6. AUTHOR(S) Daniel Matthew O'Neal			8. PERFORMING ORGANIZATION REPORT NUMBER
7. PERFORMING ORGANIZATION NAME(S) AND ADDRESS(ES) Naval Postgraduate School Monterey CA 93943-5000			10. SPONSORING/MONITORING AGENCY REPORT NUMBER
9. SPONSORING/MONITORING AGENCY NAME(S) AND ADDRESS(ES)			11. SUPPLEMENTARY NOTES The views expressed in this thesis are those of the author and do not reflect the official policy or position of the Department of Defense or the U.S. Government.
12a. DISTRIBUTION/AVAILABILITY STATEMENT Approved for public release; distribution is unlimited.		12b. DISTRIBUTION CODE	
<p>13. ABSTRACT <i>(maximum 200 words)</i></p> <p>Ambient underwater acoustic noise recordings were made in three large exhibits at the Monterey Bay Aquarium and the inner Monterey Bay, with the results reported here. Observed broadband (0-6.4 kHz) acoustic noise levels ranged from 112-125 dB re 1 <math>\mu</math>Pa for the aquarium exhibits under normal operating conditions. Broadband acoustic noise levels of 113 dB and 116 dB re 1 <math>\mu</math>Pa were observed for the nearshore and offshore bay locations, respectively.</p> <p>A comparison of the noise spectrum in the aquarium's largest exhibit to that of the environment which it attempts to simulate, the offshore bay, revealed a higher noise level of approximately 15-25 dB in the exhibit for frequencies between 20 Hz and 6.4 kHz. A similar comparison of the noise spectra of the two smaller exhibits and the nearshore bay location revealed a difference of approximately 5-10 dB across the entire frequency range of 0-6.4 kHz.</p> <p>Aquarium measurements with various mechanical equipment (motors, fans, pumps, sprinklers, wave machine) turned on and off highlighted some of the prominent ambient noise contributors. It was concluded that the pump machinery is the greatest contributor to ambient noise, with the strength directly related to the exhibits' proximity to the machinery room.</p>			
14. SUBJECT TERMS Ambient noise, Ambient noise measurements, Monterey Bay, Monterey Bay Aquarium			15. NUMBER OF PAGES <b>66</b>
17. SECURITY CLASSIFICATION OF REPORT Unclassified			16. PRICE CODE
18. SECURITY CLASSIFICATION OF THIS PAGE Unclassified	19. SECURITY CLASSIFICATION OF ABSTRACT Unclassified	20. LIMITATION OF ABSTRACT UL	





**Approved for public release; distribution is unlimited.**

**COMPARISON OF THE UNDERWATER AMBIENT NOISE MEASURED IN  
THREE LARGE EXHIBITS AT THE MONTEREY BAY AQUARIUM AND IN  
THE INNER MONTEREY BAY**

Daniel Matthew O'Neal  
Lieutenant, United States Navy  
B.A., The Citadel, 1992

Submitted in partial fulfillment  
of the requirements for the degree of

**MASTER OF SCIENCE IN APPLIED PHYSICS**

from the

**NAVAL POSTGRADUATE SCHOOL**

**June 1998**

PS Archive

998.06

D Neal, D.

~~1/23/0~~  
~~05/94~~  
G.I

## ABSTRACT

DUDLEY KNOX LIBRARY  
NAVAL POSTGRADUATE SCHOOL  
MONTEREY CA 93943-5101

Ambient underwater acoustic noise recordings were made in three large exhibits at the Monterey Bay Aquarium and the inner Monterey Bay, with the results reported here. Observed broadband (0-6.4 kHz) acoustic noise levels ranged from 112-125 dB re 1  $\mu$ Pa for the aquarium exhibits under normal operating conditions. Broadband acoustic noise levels of 113 dB and 116 dB re 1  $\mu$ Pa were observed for the nearshore and offshore bay locations, respectively.

A comparison of the noise spectrum in the aquarium's largest exhibit to that of the environment which it attempts to simulate, the offshore bay, revealed a higher noise level of approximately 15-25 dB in the exhibit for frequencies between 20 Hz and 6.4 kHz. A similar comparison of the noise spectra of the two smaller exhibits and the nearshore bay location revealed a difference of approximately 5-10 dB across the entire frequency range of 0-6.4 kHz.

Aquarium measurements with various mechanical equipment (motors, fans, pumps, sprinklers, wave machine) turned on and off highlighted some of the prominent ambient noise contributors. It was concluded that the pump machinery is the greatest contributor to ambient noise, with the strength directly related to the exhibits' proximity to the machinery room.



## TABLE OF CONTENTS

I. INTRODUCTION .....	1
II. AMBIENT NOISE IN THE SEA: SOURCES AND SPECTRA .....	3
A. STANDARD MEASURES OF BROADBAND ACOUSTIC NOISE ...	3
B. DEEP-WATER AMBIENT NOISE IN THE OCEAN .....	4
III. EXPERIMENTAL METHODS AND PROCEDURES.....	9
IV. MEASURED AMBIENT NOISE IN THE MONTEREY BAY .....	13
A. THE OFFSHORE RECORDINGS .....	14
B. THE NEARSHORE RECORDINGS .....	16
V. MEASURED AMBIENT NOISE IN THE MONTEREY BAY AQUARIUM ..	21
A. THE OUTER BAY WATERS EXHIBIT .....	21
B. THE MONTEREY BAY HABITATS EXHIBIT .....	26
C. THE KELP FOREST EXHIBIT .....	28
D. COMPARISON OF THE THREE AQUARIUM EXHIBITS .....	30
VI. COMPARISON OF AQUARIUM RESULTS TO BAY RESULTS.....	31
A. OFFSHORE BAY VERSUS OUTER BAY WATERS EXHIBIT ...	31
B. NEARSHORE BAY VERSUS THE TWO SMALLER EXHIBITS ..	32
VII. CONCLUSIONS AND RECOMMENDATIONS.....	35
A. SUMMARY .....	35
B. SUGGESTIONS FOR FURTHER INVESTIGATION .....	39
APPENDIX A. EQUIPMENT SPECIFICATIONS.....	41
APPENDIX B. AQUARIUM SCHEMATICS.....	45
APPENDIX C. MATLAB PROGRAMMING CODE.....	49
LIST OF REFERENCES.....	53
INITIAL DISTRIBUTION LIST.....	55





## **ACKNOWLEDGEMENT**

The author would like to acknowledge the help of several individuals and offer his most sincere gratitude. Commander Warren Hintz (USN, ret) was very gracious in allowing the use of his personal boat to support this research as well as lending his expertise as a seafaring guide in the not-always-friendly Monterey Bay. Aquarists Alan Young and Randy Hamilton of the Monterey Bay Aquarium were always enthusiastic in support of the research and their willingness to help was paramount in the completion of the analysis.

Finally, the author wishes to thank Professor Steve Baker for his patience and guidance throughout every facet of this work.



## I. INTRODUCTION

The primary focus of this thesis is to report the results of ambient underwater acoustic noise measurements made in three large tank exhibits at the Monterey Bay Aquarium and in the inner Monterey Bay. Although the study of ambient noise in various oceans has been extensive and is well documented, a comparison of the underwater ambient noise in a large attraction-type aquarium to that of the environment which it attempts to simulate has either never been done or has not been well publicized. This thesis reports such a comparison.

### A. RESEARCH MOTIVATION AND OBJECTIVE

It has been observed that the behavior of many species of fish is radically different when in captivity compared to the same species' behavior in its natural environment. There are many factors contributing to this difference. It is believed that the primary factor is simply the increased level of stress caused by the shock of being in a new environment. It is also believed that, aside from the initial shock of a new environment, the continuous noise level is another potential source of stress. This thesis is not an attempt to discuss the physiological effects that a high-noise environment may cause on a species, but to report these noise levels in one specific aquarium and how they differ from the species' natural environment. It is of paramount interest to aquarists to know as precisely as possible the causes of stress and, henceforth, be able to keep them to a minimum.

This investigation is the first in which acoustic ambient noise measurements were made in the Monterey Bay Aquarium. For this reason, the aquarium staff were very

enthusiastic and accommodating throughout the entire research.

## **B. THESIS OUTLINE**

This thesis is divided into seven chapters. The first is an introduction describing the motivation and objectives of the study. Chapter II is a discussion of the various sources of noise in the ocean. The third chapter describes the experimental methods and some of the characteristics of the equipment used. Chapters IV and V report the results of ambient noise measurements in the Monterey Bay and the Monterey Bay Aquarium; Chapter VI is a comparison of the two. The final chapter summarizes the results and draws some conclusions based on these results.



## II. AMBIENT NOISE IN THE SEA: SOURCES AND SPECTRA

Ambient acoustic noise is a sustained, unavoidable background of sound. It is generally broadband in nature. For the purpose of the present study, the term "ambient noise" shall mean ambient underwater acoustic noise, and shall not include transient events, such as may be caused by a passing boat or plane, or self-noise, such as that caused by cable strum or current flow around a hydrophone. As one may expect, there are a variety of sources of ambient noise in the ocean.

### A. STANDARD MEASURES OF BROADBAND ACOUSTIC NOISE

A precise definition of the underwater acoustic noise level (NL) is the average acoustic intensity level measured by a hydrophone within a specific frequency band. It is generally expressed in decibels (dB), with reference to a plane wave of 1  $\mu$ Pa rms pressure. [1,2] Broadband noise is commonly quantified by its noise spectrum level (NSL) as a function of frequency. This level, cited in most literature, is typically a noise spectrum level in dB with reference to a standard pressure per unit bandwidth, so that the effect of the bandwidth may be eliminated. Specifically,

$$NSL = NL \text{ in a 1-Hz band.}$$

Experimentally, the NSL is commonly estimated from the noise level in a  $BW$  Hz band using:

$$\text{Estimated NSL} = NL \text{ in a } BW \text{ Hz band} - 10\log(BW).$$

The units are dB re 1  $\mu$ Pa/sqrt-Hz. [1] Actually, this noise spectrum level (in a 1-Hz band) should be referred to as the noise spectral density level. It should be noted, however,

that, to remain consistent with current literature, this report will use the generic label of NSL as the equivalent of the noise spectral density level or noise spectrum level in a 1-Hz band.

The computation and presentation of the NSL versus frequency is commonly termed a "narrow band analysis". Also reported herein are the results of one-third-octave band analyses. For these, standard one-third-octave frequency bands were employed [2].

### B. DEEP-WATER AMBIENT NOISE IN THE OCEAN

The ambient noise spectrum is the result of the superposition of contributions of different physical origins. Figure 2.1 shows a group of representative deep-water ambient NSL spectra for different conditions. The shipping traffic (or density) is difficult to accurately estimate and is primarily estimated strictly as a function of distance from the nearest shipping lane.

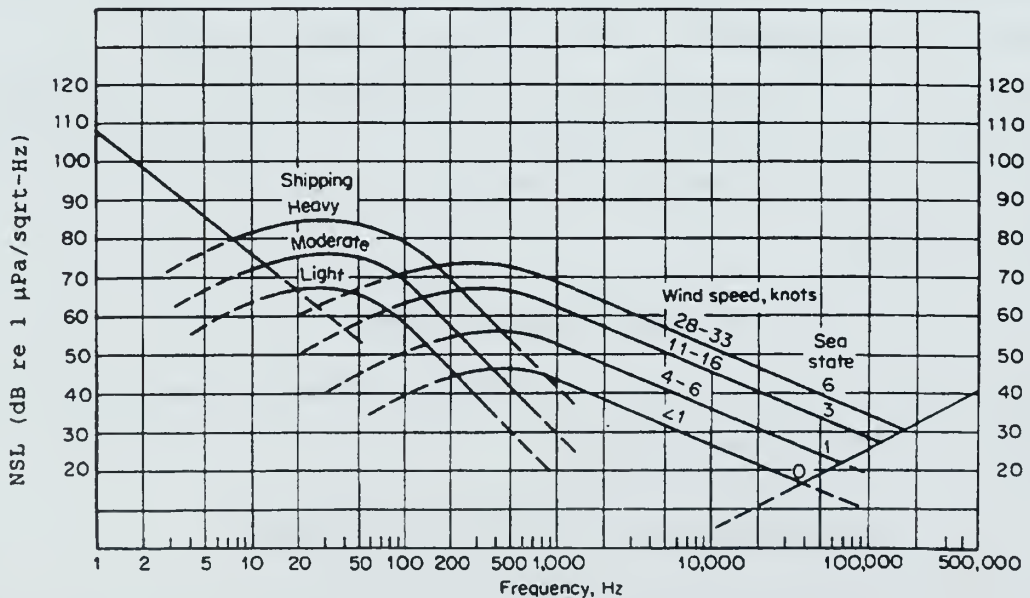

Figure 2.1. Average deep-water ambient noise spectral density levels [2].

In various frequency regions of the spectrum, a single source mechanism is dominant. Urick defined a convenient breakdown of the frequency bands and the principal sources of noise contributors within these bands in his *Principles of Underwater Sound* [3]. Etter [4] and Carey and Fitzgerald [5] also used these frequency bands in their own discussions of the dominant ambient noise sources. A brief summary follows.

Band I contains frequencies below 1 Hz. Accurate measurements in this band are difficult to make due to the self-noise of the hydrophone in even the most minimal currents. The most likely contributor of noise in this band is seismic activity. Urick defined Band II between 1 and 20 Hz. It is almost always characterized by the -8 to -10 dB/octave slope and is most likely a result of oceanic turbulence. The slope flattens in Band III (20 to 500 Hz). High wind speeds can contribute to the noise in the upper portion of this band but it is generally dominated by distant shipping. Band IV is the largest and perhaps the best known. It spans from 500 Hz to about 50 kHz and contains the familiar Knudsen Spectra. It is characterized by a -5 to -6 dB/octave slope and is dominated by surface noise (wind and sea state). It is now known that this "surface noise" is the result of damped radiations from newly formed microbubbles created by spilling breakers, sometimes referred to as "screaming infant microbubbles". [6] Band V is the ultrasonic band (>50 kHz) and is dominated by thermal agitation. [2]

R.F.W. Coates [7] further simplified the work of Urick [3] and Wenz [8] with his empirical formulas for estimating the noise levels from the primary contributors. The individual noise spectrum levels are

$$NSL_{therm} = -15 + 20\log(f) \quad (2.1)$$

$$NSL_{surf} = 50 + 7.5\sqrt{w} + 20\log(f) - 40\log(f + 0.4) \quad (2.2)$$

$$NSL_{ship} = 40 + 20(D - 0.5) + 26\log(f) - 40\log(f + 0.03) \quad (2.3)$$

$$NSL_{turb} = 17 - 30\log(f) \quad (2.4)$$

where  $f$  is the frequency in kHz,  $D$  is the shipping density parameter, which ranges from 0 (very light) to 1 (heavy), and  $w$  is the wind speed in m/s. The overall noise spectrum level can then be calculated as

$$NSL = 10\log\left(10^{NSL_{therm}/10} + 10^{NSL_{surf}/10} + 10^{NSL_{ship}/10} + 10^{NSL_{turb}/10}\right). \quad (2.5)$$

The resulting units from the above estimations are all in dB re 1  $\mu$ Pa/sqrt-Hertz. Figure 2.2 is a plot of the overall average deep-water ambient NSL for frequencies ranging from 1 Hz to 1000 kHz, using equations 2.1-2.5. Coates' formulae were used throughout the present investigation to estimate typical deep-water ambient noise spectra.

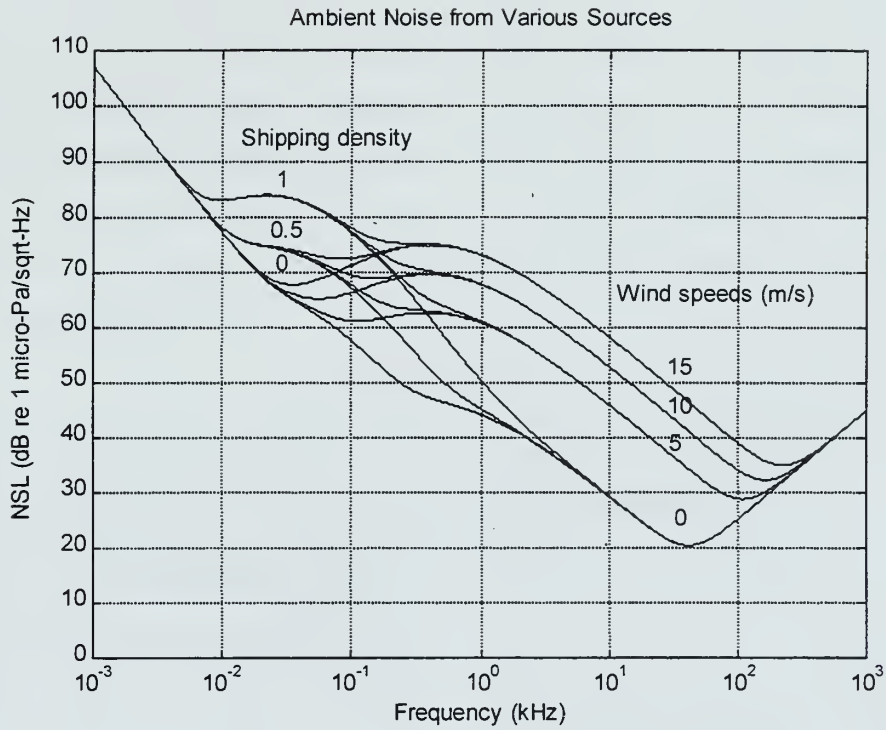

**Figure 2.2.** Estimated deep water ambient noise spectrum level (NSL) over the frequency range from 1 Hz to 1000 kHz. Adopted from Coates [3].





### III. EXPERIMENTAL METHODS AND PROCEDURES

Experimental underwater ambient acoustic noise data were gathered using three primary components: a hydrophone, a preamplifier, and a stereo digital tape recorder. Figure 3.1 is a block diagram of the basic setup. All recordings were made using a single, Navy type DT-276 hydrophone. It has a relatively flat open-circuit free-field voltage sensitivity up to approximately 6.5 kHz, with a down-3-dB-point at approximately 6.8 kHz. The hydrophone specifications and typical frequency response curves can be seen in Appendix A.

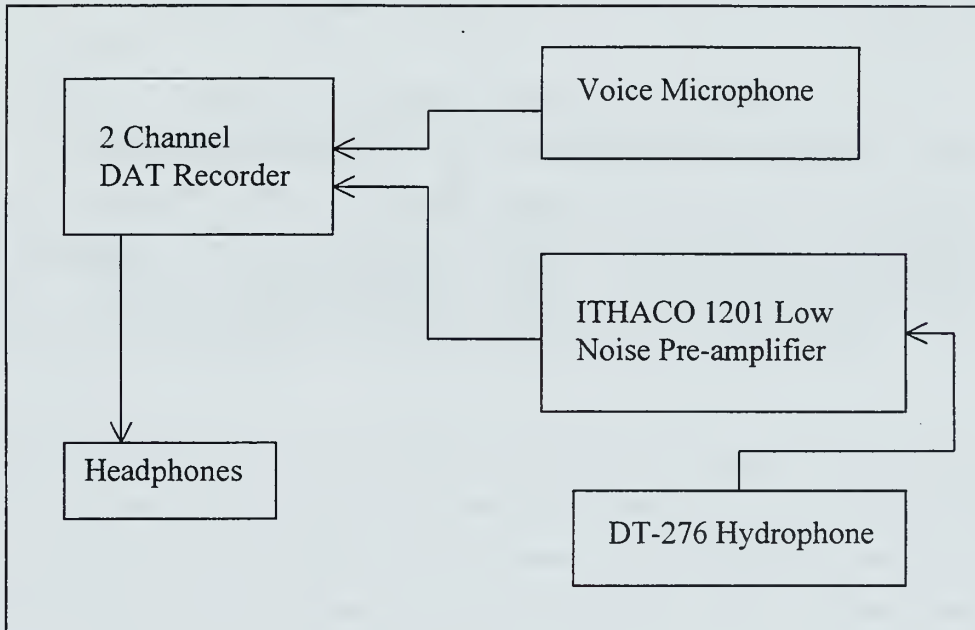

Figure 3.1. Recording equipment setup.

The preamplifier used was ITHACO's model 1201 Low Noise Preamplifier. The preamplifier filtered the signal (high and low pass), amplified it, and then passed it to one channel of a TASCAM DAP-1 Digital Audio Tape (DAT) recorder.

The DAP-1 is a 16-bit digital audio tape recorder. All recordings were made using a sampling rate of 48 kHz. The gain on the preamplifier was set such that a typical recorded signal was commonly in excess of 10% of the full scale. The specifications of the preamplifier and DAT recorder can be seen in Appendix A.

A voice microphone was connected to the second channel of the recorder to document the events and conditions. Headphones were used to listen to the underwater recordings. The preamplifier and recorder were operated using their own battery power supplies.

The general specifications of the ITHACO preamplifier and the TASCAM recorder are listed in Appendix A. Table 3.1 lists some of the specific settings used.

TABLE 3.1 Recording equipment settings

ITHACO Low Noise Preamplifier		TASCAM Digital Recorder	
Gain	100	Input	Analog
Filter, High Pass (6 dB/octave)	30 Hz	Analog Input	Microphone
Filter, Low Pass (6 dB/octave)	30 kHz	Sampling Frequency	48 kHz
Input Coupling	AC	Phantom Power Supply	Off

The hydrophone cable was wound onto a portable garden hose reel for easy transporting and deploying/retrieving. The bay recordings were made from a small, 14-ft sport-fishing boat, with the hydrophone suspended directly over the side. The boat's motor and built-in electrical equipment were off during the recordings. The aquarium recordings were made with the hydrophone either suspended from above using a rigid pole (to maintain sufficient distance from the walls) or, in the case of the largest exhibit, the hydrophone was suspended from the feeding platform. Schematic drawings of the three aquarium

exhibits, showing the hydrophone locations can be seen in Appendix B.

The equipment setup was ideal for recording in relatively mild conditions such as those encountered in the aquarium exhibits. This was not the case, however, for the bay recordings, particularly in locations far from shore. The rise and fall of the hydrophone with the swells often caused enough of a pressure variation on the hydrophone to overload the preamplifier. For this reason, the recordings were often difficult to make, and on a few occasions, no usable data were taken.

The raw audio tape recordings were all played in the laboratory. Listening to the two channels separately, and often at different volumes, made the selecting of pertinent short segments from hours of recordings a more manageable task. Verbal comments such as "The wave machine is now off," or "We are now recording at a latitude and longitude of..." were also helpful in selecting records. Listening to the hydrophone channel alone allowed for the eliminating of blocks of recordings in which the preamplifier was overloading too often. A minimum of eight seconds of uninterrupted data was needed for the broadband analyses.

Representative 8-second segments of noise were selected and analyzed using a Hewlett Packard Dynamic Signal Analyzer (Model 35665A). The gain of the preamplifier and DAT recorder, as well as the average low-frequency hydrophone sensitivity, were compensated for in the data analysis. No compensation was made for the variation in hydrophone frequency response, since the response is flat to within  $\pm 1$  dB up to 6.4 kHz—the upper frequency limit of the narrow-band analyses performed.

From the chosen segments, 16 contiguous, 125-ms time records were selected for narrowband analysis. A Hanning

window was applied and a fast Fourier transform was performed on each record. Overlap processing was not employed. The mean-square pressure in a 12-Hz (equivalent noise) band was computed for each record for frequencies from 0 to 6.4 kHz, with an 8-Hz filter spacing. The results for the 16 records were then rms averaged. They are presented in Chapters V through VII as average power spectral density level, or noise spectrum level (NSL), versus frequency.

The empirical estimations of noise spectrum levels following Coates (Figure 2.2) were also plotted along with these NSLs. Values for the wind speeds and shipping density variables were chosen to be fairly representative of the conditions encountered or in the case of the aquarium exhibits, to be typical of the conditions they are intended to model.

A broadband, or one-third-octave analysis was also performed on these same segments, from 10 Hz to 8 kHz. The standard center frequencies of the one-third-octave bands were used [2]. A linear average was taken using an average time of 8 seconds.

Both the narrowband and the one-third-octave analyses were saved to standard 3.5 inch floppy disks and then viewed with the Hewlett Packard Data Viewer software, model HP 35639A. These data were then converted to a MATLAB-usable format and the resulting plots were generated using MATLAB. Appendix D shows samples of the programming code used.



#### IV. MEASURED AMBIENT NOISE IN THE MONTEREY BAY

Recordings were made in several locations in the inner Monterey Bay. For the purpose of this investigation, data from two typical locations will be presented. They are representative nearshore (NS) and offshore (OS) positions. Figure 4.1 shows where the recording positions are located geographically.

The offshore position was approximately five miles off the California coast, just west/south-west of the mouth of the Salinas River. The bottom consisted primarily of mud and was approximately 270 feet (82.3 m) in depth.

The nearshore position was less than one mile from the coast, just inside Point Pinos. The bottom was a mixture of sand, gravel and shells and was 80 feet (24.4 m) deep.

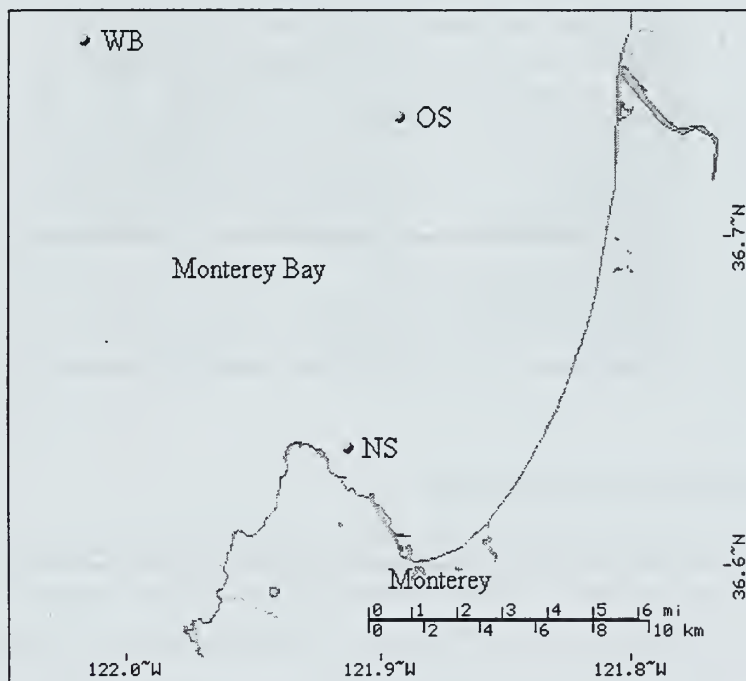

Figure 4.1. Locations of nearshore (NS) and offshore (OS) measurement positions and of weather buoy (WB) [9].

Table 4.1 lists the pertinent environmental data for both locations. The water depth, water temperature, and air temperature were recorded at the actual position where the recordings were taken. The sea state is a "best guess" estimation based on personal professional experience. The wind speed for the offshore location was taken to be the same as that measured at the Weather Buoy (WB in Figure 4.1). The nearshore locations were often shielded, and despite what value was reported at the Weather Buoy, the wind speed at the recording location would be clearly less. Fortunately, in these cases, the wind at the recording location was usually negligible and was thus taken to be either 0 or 2 m/s in Coates' formulae for estimating the noise spectrum levels.

**Table 4.1** Environmental conditions at Monterey Bay measurement positions.

Position	Offshore	Nearshore
Date	10 May 1997	10 July 1997
Time	1000	1030
Latitude	36° 41.2' N	36° 38.1' N
Longitude	121° 53.8' W	121° 54.8' W
Water Depth	270 ft (82.3 m)	80 ft (24.4 m)
Hydrophone Depth	40 ft (12.2 m)	40 ft (12.2 m)
Water Temp	14.0°C	13.3°C
Estimated Sea State	2-3	1
Wind Speed/Dir (at WB)	7 m/s 340°	<1 m/s N/A
Air Temp	18.3°C	20°C

#### **A. THE OFFSHORE RECORDINGS**

The data presented here were recorded on 10 May 1997 under fairly moderate conditions. The wind speed (recorded at the weather buoy) was 7 m/s and the sea state was approximately 2 (calm surface with 2-3 foot swells). The hydrophone was at a depth of 40 feet (12.2 m).

A one-third-octave-band analysis was performed on selected samples from these recordings with the HP Signal Analyzer and is shown in Figure 4.2.

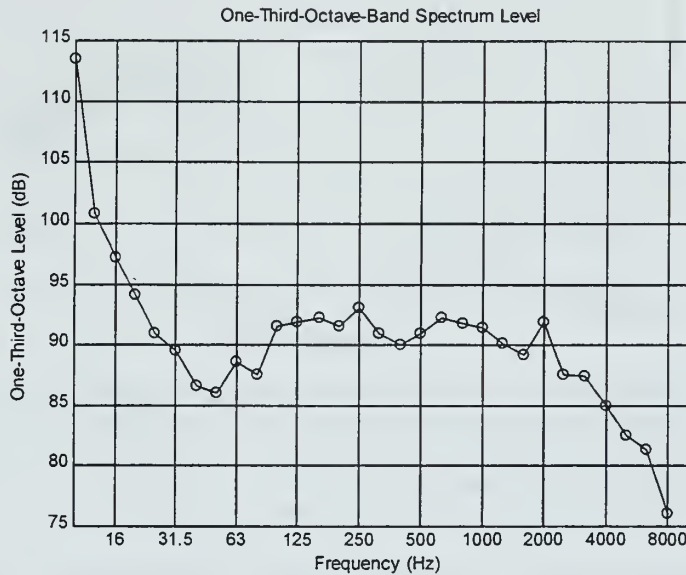

**Figure 4.2.** One-third-octave-band noise spectrum for the Monterey Bay offshore location.

A narrow band analysis was also performed on these data (Figure 4.3). The smooth curves are estimated NSL curves following Coates (Chp. 2, Part B). The values used for the shipping density and wind speed are 0 and 0.5, and 2 and 10 m/s, respectively.

There is a peak of unknown origin at approximately 3 kHz that appears in both the one-third-octave-band and the narrow-band analyses.

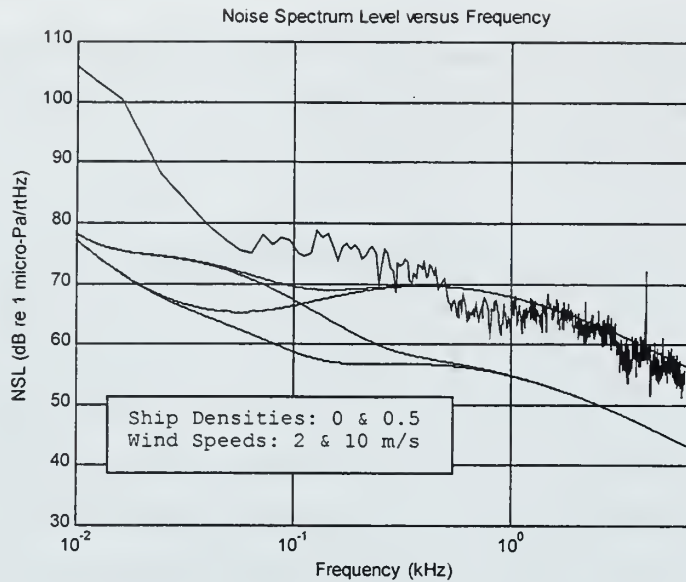

**Figure 4.3.** Observed 12-Hz-band-average NSL versus frequency for the bay offshore location. The estimated NSLs are for  $D=0$  and 0.5 and  $w=2$  and 10 m/s. Total broadband (0-6.4 kHz) NL is 116 dB re 1  $\mu$ Pa.

The measured NSLs follow closely those calculated using Coates' empirical estimations in the frequency range dominated by wind speed and sea state (>200 Hz). They are, however, noticeably higher than calculated in the frequency region dominated by shipping density (20 to 500 Hz). This leads one to believe that, although shipping traffic is light in the Monterey Bay, there may be significant noise contributors from the lanes between Los Angeles and San Francisco, and even Santa Cruz.

## B. THE NEARSHORE RECORDINGS

The data presented here were recorded on 10 July 1997 under very favorable conditions. Both the wind and the sea state were negligible. Again the hydrophone was at a depth of 40 feet (12.2 m).

A one-third-octave-band analysis was performed on this data and is shown in Figure 4.4.

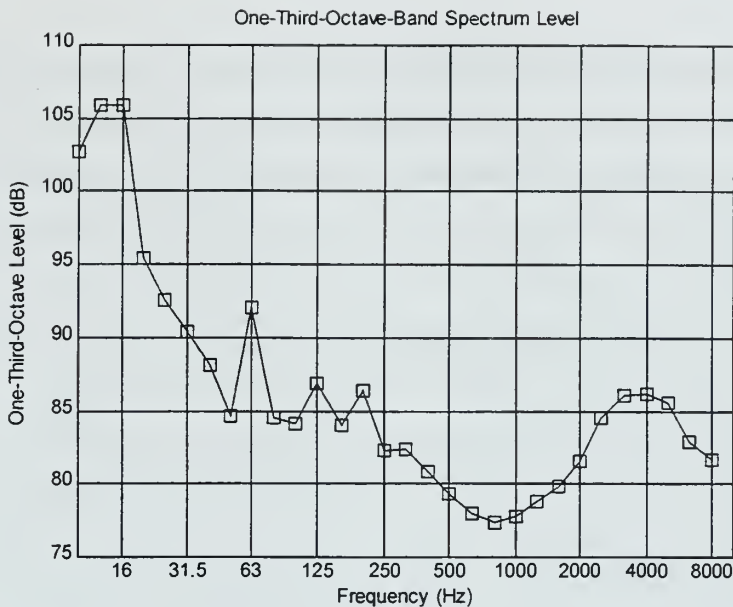

**Figure 4.4.** One-third-octave-band noise spectrum for the Monterey Bay nearshore location.

A narrow band analysis of these same data was performed (Figure 4.5). Again the smooth curves are the empirical estimations using 0 and 0.5 for the shipping density and 2 and 5 m/s for the wind speed in Coates' formulae.

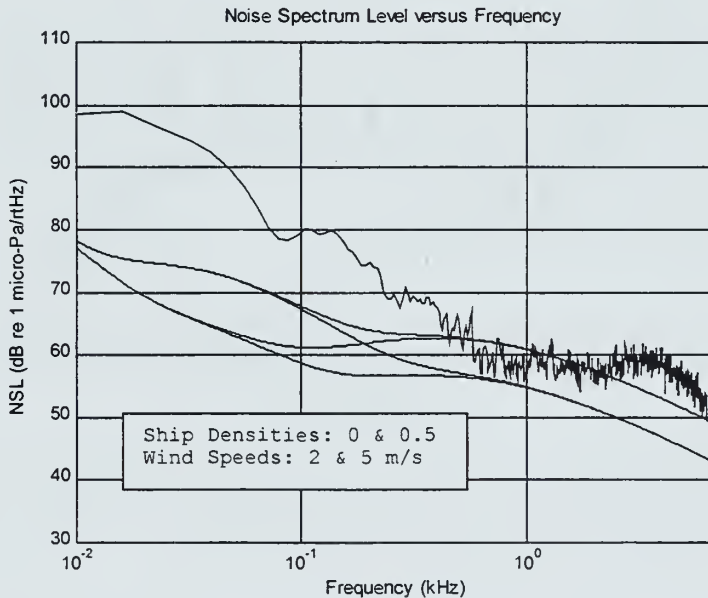

**Figure 4.5.** Observed 12-Hz-band-average NSL versus frequency for the bay nearshore location. The estimated NSLs are for  $D=0$  and  $0.5$ , and  $w=2$  and  $5$  m/s. Total broadband (0-6.4 kHz) NL is 113 dB re  $1 \mu\text{Pa}$ .

The measured NSLs follow the general trend of the estimated values, again with significantly higher levels in the shipping density frequency regime (20 Hz-500 Hz).

A comparative analysis of the one-third-octave-band NSLs is shown in Figure 4.6. The offshore levels are consistently higher, particularly in the region dominated by wind speed (>200 Hz). Both curves show peaks at approximately 60 Hz, although the nearshore peak is significantly larger. Also of interest are the peaks in the nearshore NSL at approximately 120 and 240 Hz. Since all bay recordings were made with the equipment operating on battery power, these can most likely be attributed to industrial noise from nearby shore sources.

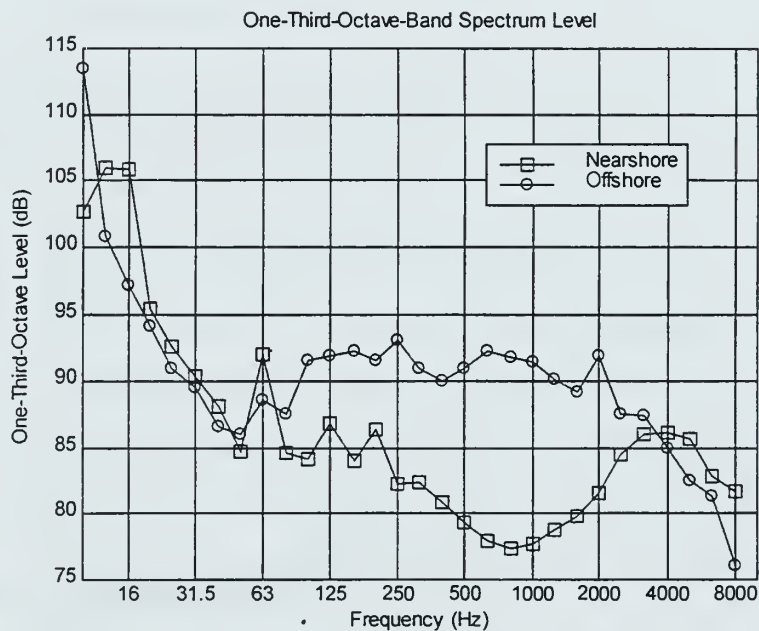

**Figure 4.6.** One-third-octave-band noise spectra for the Nearshore and Offshore locations. Total broadband NLs are 113 dB and 116 dB (re 1  $\mu$ Pa) for Nearshore and Offshore, respectively.



A comparative look at the narrow-band analysis is shown in Figure 4.7. Again, the primary difference in the NSLs of the two locations lies in the wind dominated region of the frequency spectrum ( $>200$  Hz).

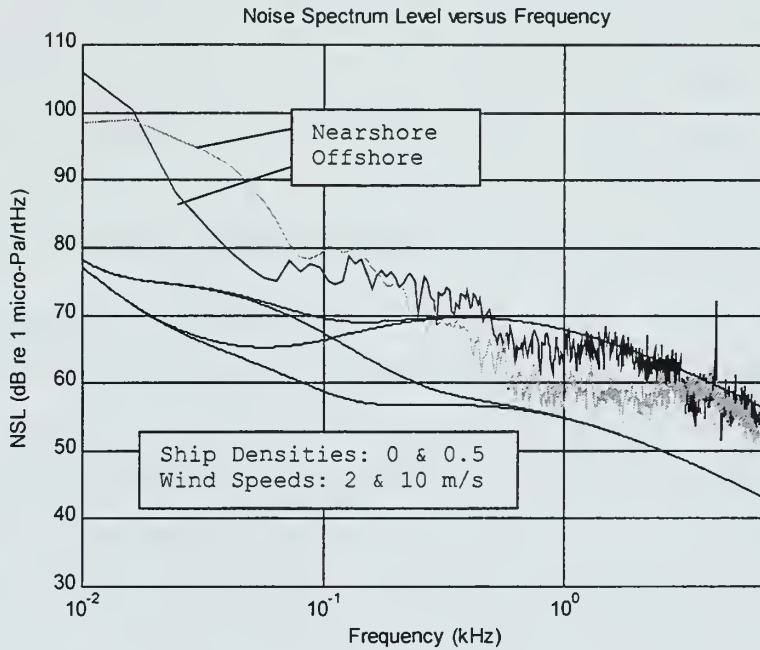

**Figure 4.7.** Observed 12-Hz-band-average NSL versus frequency for the Nearshore and Offshore locations. The estimated NSLs are for  $D=0$  and 0.5, and  $w=2$  and 10 m/s. Total broadband (0-6.4 kHz) NLs are 113 dB and 116 dB re 1  $\mu$ Pa for Nearshore and Offshore, respectively.





## **V. MEASURED AMBIENT NOISE IN THE MONTEREY BAY AQUARIUM**

Recordings of underwater ambient acoustic noise were made in the three largest tank exhibits of the Monterey Bay Aquarium: the Kelp Forest Exhibit, the Monterey Bay Habitats Exhibit, and the Outer Bay Waters Exhibit. Measurements were made with various mechanical equipment (motors, fans, pumps, sprinklers, wave machine) both on and off.

### **A. THE OUTER BAY WATERS EXHIBIT**

#### **1. Operating specifics**

The Outer Bay Waters (OBW) exhibit is the aquarium's largest exhibit. It contains 1.4 million gallons of water of which 880,000 gallons are visible. The remainder is between the cosmetic false-bottom and the 22-inch concrete reinforced structure walls. It has a maximum length of 90 feet (27.4 m), maximum width of 52 feet and 6 inches (16 m), and height of 35 feet (10.7 m) with a water depth of 32 feet (9.8 m). The semi-elliptical shape of the exhibit can be seen in Appendix B, Drawing 1.

The main viewing area is 54 feet (16.5 m) long and 14 feet 4 inches (4.3 m) high and made of a 10-inch thick acrylic window. The exhibit spans the height of all three floors of the aquarium, and is viewed from the first and second floors. The service area for the exhibit is located on the third floor, with the exterior roof of the building directly overhead. The area is not air conditioned but contains ventilation fans mounted on an exterior wall. The ventilation fans cycle on and off depending on the air temperature.

Seawater is piped in from the bay from an inlet located approximately 900 feet (274 m) out and a depth of 50 feet

(15.2 m). It is passed through particulate filters, into the exhibit, and back out to the bay at a rate of 7,150 gallons per minute. The water temperature is consistent with the bay and therefore primarily changes only from season to season. The pump machinery room is located on part of the second and third floors in close vicinity to the exhibit. The seawater circulation system is continuously in operation.

A bubble curtain, located just inside the viewing glass, is normally in continuous operation during non-business hours. Its purpose is to alert fast-swimming fish to the presence of the window, and thus to minimize the likelihood of injury due to a collision with the glass.

## 2. Ambient Noise Spectrum Levels

Recordings were made in the OBW under various typical operating conditions, primarily with the pump machinery on, and the fans and bubble curtain both on and off. The recording position can be seen in Appendix B, Drawing 1. On one occasion we were lucky enough to have the opportunity to record during a complete power outage of the east wing, a rare occurrence during which time maintenance was being performed on the aquarium's power plant. There was approximately a 30 minute time window before the portable generators were brought online. Table 5.1 lists the broadband noise levels (0-6.4 kHz) observed for the various equipment conditions.

**Table 5.1.** Measured broadband (0-6.4 kHz) noise levels (NL) for the various operating conditions.

Condition	NL (0-6.4 kHz) (dB re 1 $\mu$ Pa)
Pumps on, Fans on, Bubbles on	124
Pumps on, Fans on, Bubbles off	125
Pumps on, Fans off, Bubbles off	121
Total Power Outage	110

With regard to the mechanical equipment, the typical condition of the OBW exhibit during normal business hours is pumps and fans on and the bubble curtain off. This is also its noisiest condition. The non-business hours condition is the same, with the exception of the bubble curtain being activated. It is interesting to note that the bubble curtain in the OBW Exhibit actually suppresses the noise for frequencies below approximately 500 Hz. Figure 5.1 shows the measured average NSL for these two conditions. Also plotted are the same estimated NSL curves from Figure 2.2, appropriate for a deep water environment. These estimates use shipping densities of 0 and 0.5, and wind speeds of 2 and 10 m/s.

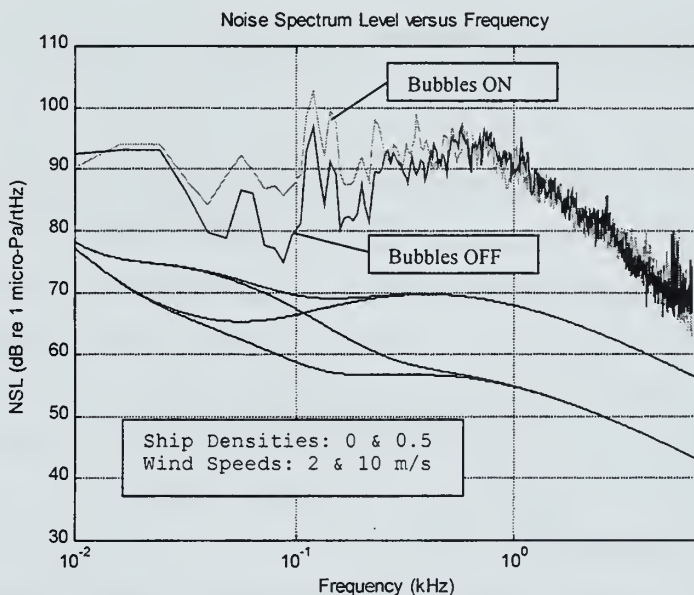

**Figure 5.1.** Observed 12-Hz-band-average NSL versus frequency for the two primary operating conditions of the OBW Exhibit with the pumps and fans on and the bubble curtain both on and off. The estimated NSLs are for  $D=0$  and  $0.5$ , and  $w=2$  and  $10$  m/s. Total broadband (0-6.4 kHz) NLs are 124 dB and 125 dB re 1  $\mu$ Pa for bubbles on and off, respectively.

Figure 5.2 shows the results of one-third-octave-band analysis of the same data.

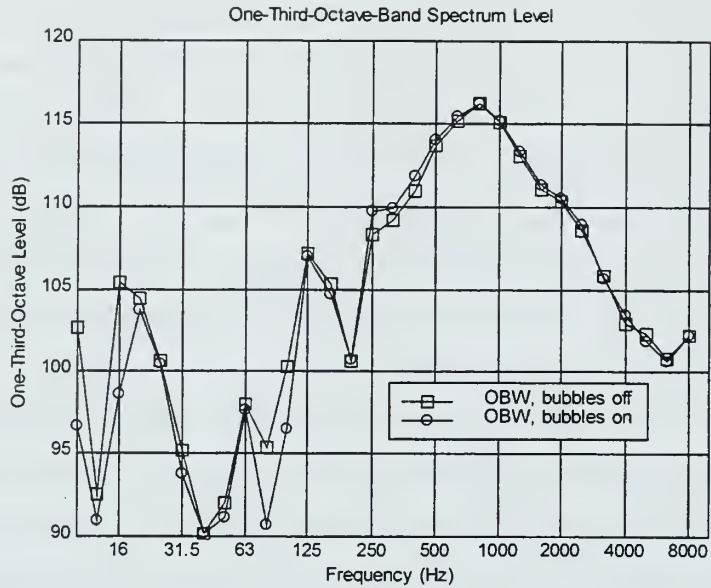

**Figure 5.2.** Observed one-third-octave-band noise spectra versus frequency for the two primary operating conditions of the OBW Exhibit.

Figure 5.3 shows a comparison of the average NSL spectrum of the OBW Exhibit for the most prevalent condition of pumps, fans, and bubble curtain on, and also for the total power out condition. Also plotted are estimated NSL curves for parameter values of  $D=0$  and  $0.5$ , and  $w=2$  and  $10$  m/s. Note that all of the spectra show the power-line and synchronous motor contributions at 60 and 120 Hz, and another strong contribution at 150 Hz. The 60 Hz peak is still visible in the case with the power out; however it is not as prominent. This is most likely due to leaking noise from the west wing of the aquarium, which was powered normally during the east wing power shutdown.

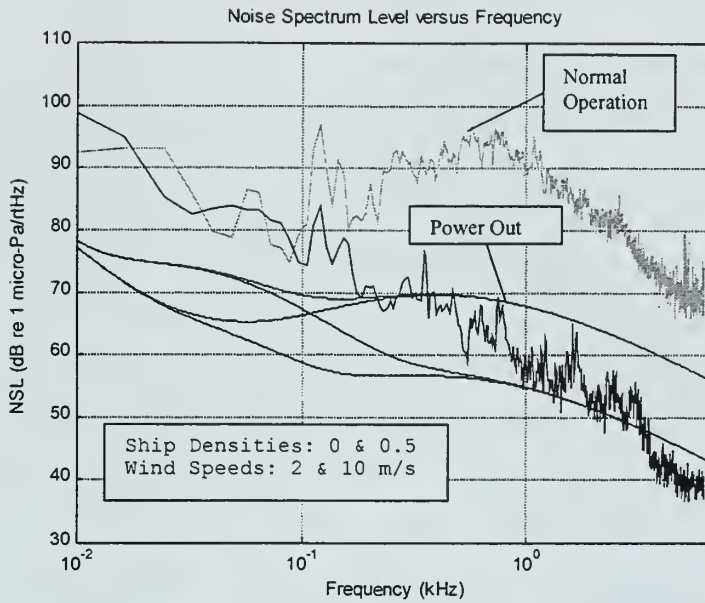

**Figure 5.3.** Observed 12-Hz-band-average NSL versus frequency of the OBW exhibit for the most prevalent operating condition and for the total power out condition. The estimated NSLs are for  $D=0$  and  $0.5$ , and  $w=2$  and  $10$  m/s. Total broadband (0-6.4 kHz) NLs are 110 dB and 124 dB re  $1 \mu\text{Pa}$  for OBW power out and normal operation, respectively.

Figure 5.4 represents a one-third-octave-band noise spectra of the same data.

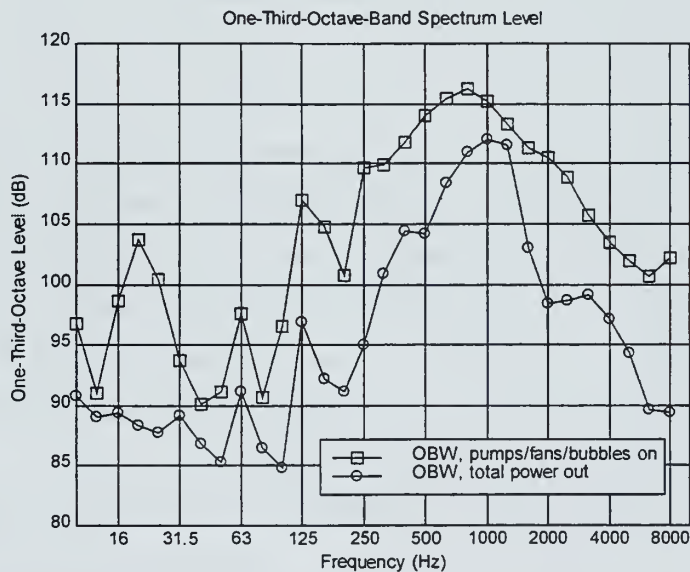

**Figure 5.4.** Observed one-third-octave-band noise spectra versus frequency for the normal OBW condition and the power out condition.



## **B. THE MONTEREY BAY HABITATS EXHIBIT**

### **1. Operating Specifics**

The Monterey Bay Habitats Exhibit is the aquarium's second largest exhibit. It contains 350,000 gallons of water. Its maximum length is 91 feet (27.7 m) and is 35 feet (10.7 m) wide at each end. It has a depth of 17 feet (5.2 m) at the Deep Reefs end and 14 feet (4.3 m) at the Wharf end. The acrylic windows are 3-4 inches thick and the walls are 16 inch thick concrete. The rock work is concrete reinforced with about two inches of fiberglass sprayed onto a fiberglass framework. There are two grating drains leading to the main water outlet. The exact size and locations of the rockwork and drains can be seen in Appendix B, Drawing 2.

The Monterey Bay Habitats Exhibit is intended to reproduce local shallow-water environments which might include, for example, a sandy seafloor, a reef, or wharf pilings.

### **2. Ambient Noise Spectrum Levels**

Ambient noise recordings were made at a lateral distance of six feet (1.8 m) from the side wall and at a depth of six feet (1.8 m). The exact position is annotated in Appendix B, Drawing 2. The exhibit has basically just one operating condition--pumps on. The recordings were made in this condition during normal business hours with a moderate amount of visitors. The primary noise contributors are from water flow, pump machinery noise, and the visitors outside of the seven viewing windows.

The measured broadband noise level (NL) under this condition was 118 dB (re 1  $\mu$ Pa). Figure 5.5 is a plot of the observed 12-Hz band average NSL versus frequency.



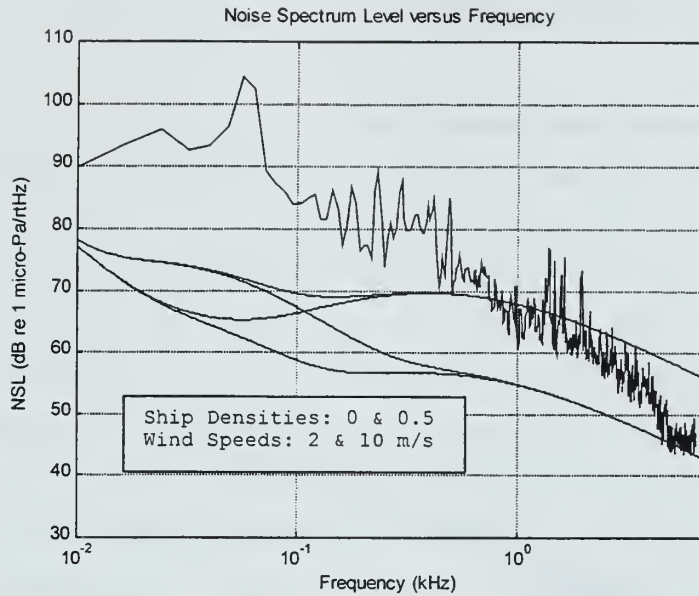

**Figure 5.5.** Observed 12-Hz-band-average NSL versus frequency for the Monterey Bay Habitats Exhibit. The estimated NSLs are for  $D=0$  and  $0.5$ , and  $w=2$  and  $10$  m/s. Total broadband (0-6.4 kHz) NL is 118 dB re  $1 \mu\text{Pa}$ .

Figure 5.6 represents the same data as a one-third-octave-band noise spectrum.

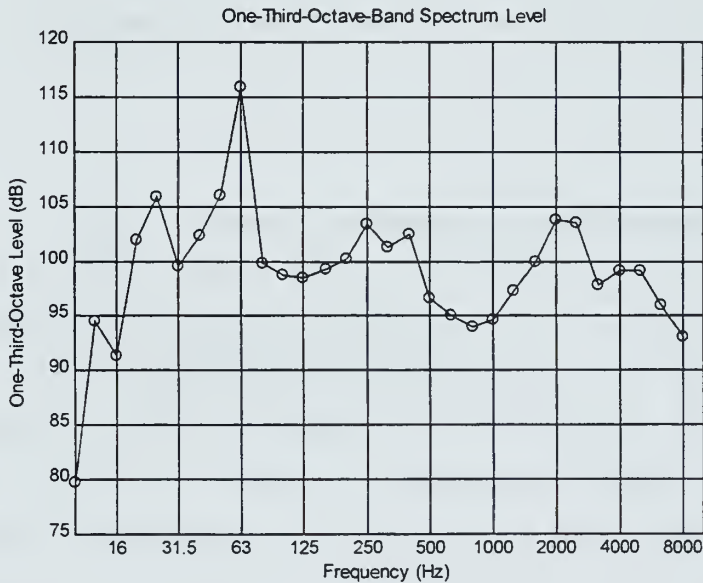

**Figure 5.6.** Observed third-octave-band noise spectrum versus frequency for the Habitats.

## **C. THE KELP FOREST EXHIBIT**

### **1. Operating Specifics**

The Kelp Forest Exhibit is the third of the three large tanks at the Monterey Bay Aquarium. It contains 335,000 gallons of water. It measures 66 feet (20.1 m) in length with a height of 31 feet (9.4 m) with 28 feet (8.5 m) of water. The walls of the exhibit are 16 inches thick except where they join the Monterey Bay Habitats where they are 22 inches. The exhibit spans all three levels of the aquarium with viewing areas on the first and second floors. The dimensions of the exhibit can be seen in Appendix B, Drawing 3.

A piston/plunger built into the rockwork in the upper left area of the exhibit creates a surface wave displacement of up to one and a half feet. The flow rate into the tank is between 2000 and 3000 gallons per minute.

The surface of the exhibit is on the roof of the building and is open to the elements. This is to allow natural sunlight for the photosynthesis needed for the kelp. There are also mist sprinklers on the surface to simulate sea spray.

### **2. Ambient Noise Spectrum Levels**

Ambient noise recordings were made at a lateral distance of 6 feet (1.8 m) from the side wall and at a depth of 12 feet (3.7 m). The standard condition of the Kelp Forest Exhibit has the surface sprinklers in continuous operation and the wave machine on during business hours. We made recordings with the waves and sprinklers both on and off. Of particular interest in our analysis is the comparison between the conditions of waves on and waves off. These are the two primary operating conditions.

The measured broadband noise level (NL) during the standard (waves on) condition was 112 dB (re 1  $\mu$ Pa). Figure 5.7 and 5.8 show the narrow-band and the one-third-octave band NSLs for both conditions (waves on/waves off).

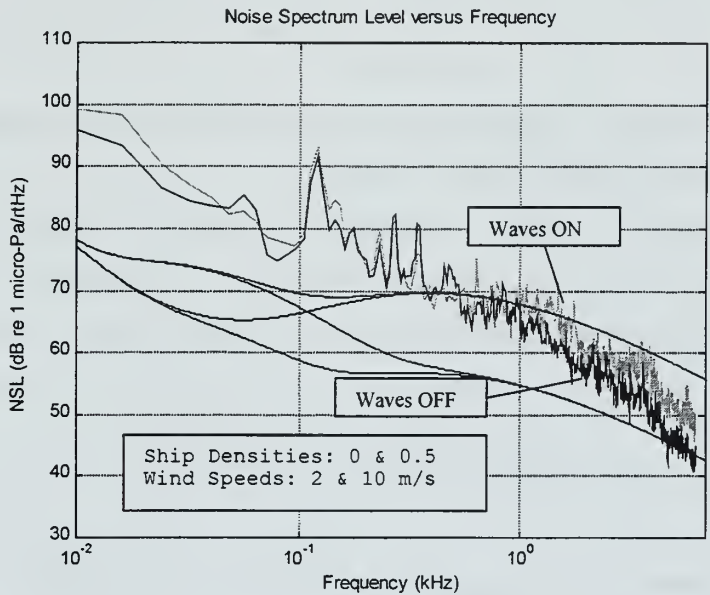

**Figure 5.7.** Observed 12-Hz-band-average NSL versus frequency in the KFE with the wave machine both on and off. The estimated NSLs are for  $D=0$  and  $0.5$ , and  $w=2$  and  $10$  m/s. Total broadband ( $0-6.4$  kHz) NLs are  $114$  dB and  $112$  dB re  $1 \mu\text{Pa}$  for the KFE with waves off and on, respectively.

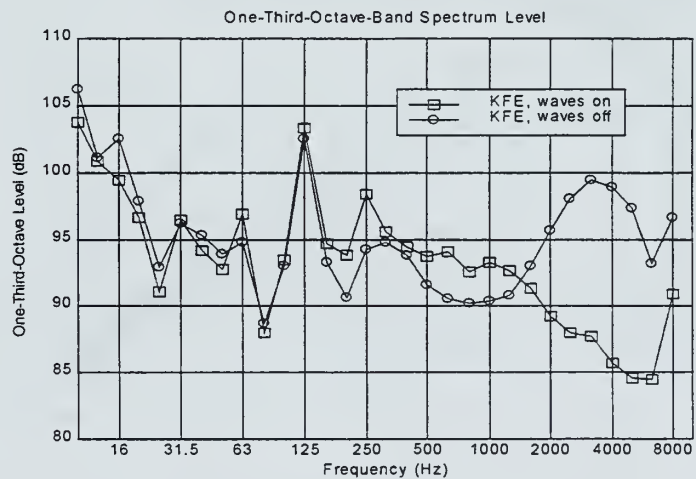

**Figure 5.8.** Observed third-octave-band noise spectra versus frequency for the KFE.

#### D. COMPARISON OF THE THREE AQUARIUM EXHIBITS

The obvious difference between the three largest exhibits in the Monterey Bay Aquarium is the volume of water contained in each. The other differences may seem subtle to the common observer but could be significant to the noise levels in each. The differences discussed here are the exhibits' proximity to the pump machinery room and the flow rate of the water into the tanks.

The same machinery is used to pump bay water into all three exhibits via one large pipeline. The pump machinery is housed in the same building as the OBW and is very near in proximity to the actual walls of the tank. Both the Habitats Exhibit and the Kelp Forest Exhibit are located in the opposite wing of the facility, at a distance of several hundred feet from the pump machinery. The flow rate into the OBW is over 7100 gpm and is between 2000-3000 gpm for the two smaller exhibits.

Figure 5.9 shows the narrow-band NSLs of the OBW, along with the NSLs of the KFE and the Habitats exhibit, all under normal operating conditions.

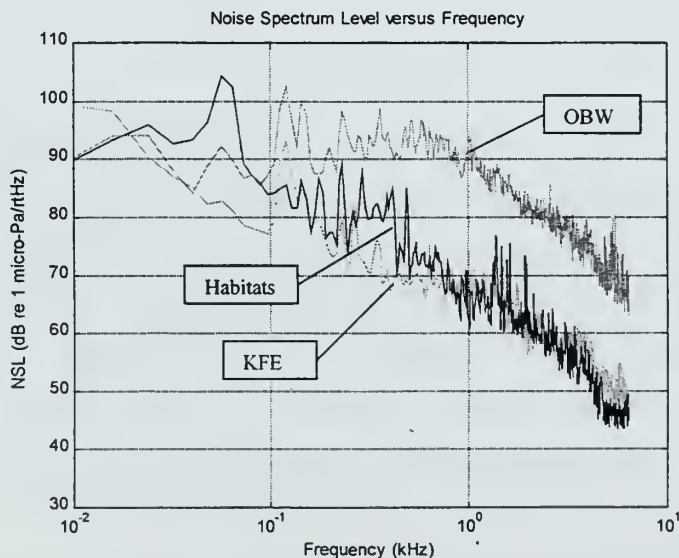

**Figure 5.9.** Observed 12-Hz-band-average NSL versus frequency in the OBW, KFE and Habitats. Total broadband (0-6.4 kHz) NLs are: OBW, 124 dB; Habitats, 118 dB; KFE, 112 dB re 1  $\mu$ Pa.

## VI. COMPARISON OF AQUARIUM RESULTS TO BAY RESULTS

The following are the comparisons of the narrow-band NSLs of the exhibits and the environment with which they are most closely meant to simulate.

### A. OFFSHORE BAY VERSUS OUTER BAY WATERS EXHIBIT

The first comparative analysis shown will be two narrow-band NSLs of the OBW exhibit compared to a typical NSL of the offshore location in the Monterey Bay (Figure 6.1). Shipping densities of 0 and 0.5, and wind speeds of 2 and 10 m/s were used for the estimated curves.

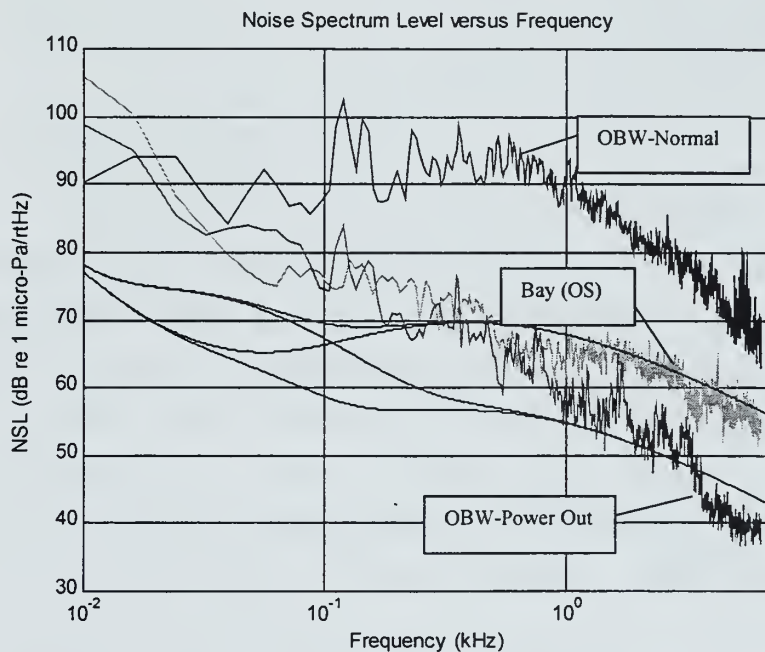

**Figure 6.1.** Observed 12-Hz-band-average NSL versus frequency for the two extreme OBW conditions and for the Offshore Bay location. The estimated NSLs are for  $D=0$  and  $0.5$ , and  $w=2$  and  $10$  m/s. Total broadband (0-6.4 kHz) NLs are: OBW-normal, 124 dB; Bay(OS), 116 dB; OBW-power out, 110 dB re 1  $\mu$ Pa.

The measured broadband (0-6.4 kHz) noise levels are: for the OBW, 124 dB (re 1  $\mu$ Pa); for the Kelp Forest Exhibit, 112 dB; and for the Habitats Exhibit, 118 dB.



The OBW-normal spectrum data came from recordings with the pumps on and the bubble curtain off. Both this spectrum and the total-power-out spectrum follow similar trends and show the expected peaks at approximately 60, 120 and 150 Hz. The notable difference between the two is the 25-30 dB increase in level between the normal and power-out conditions for frequencies above 100 Hz.

This was somewhat expected; the results of real interest are the magnitudes of the differences shown between the NSLs of the aquarium, as it typically operates, and the environment which it attempts to simulate. Except for the region below approximately 20 Hz, the aquarium is significantly louder. The difference is about 15-25 dB from 100 to 1000 Hz and approaches about 10 dB for frequencies in the range of 4000 to 6000 Hz.

What was not anticipated was how the bay noise compares to the aquarium with the power out. The spectra are similar up to about 1000 Hz but the aquarium is actually quieter than the bay at frequencies greater than this. Realizing that this situation is not a possibility for any aquarium to normally operate under, it does however lead one to believe that further study of the predominant noise sources and transmission paths could lead to suppression measures that may significantly reduce the aquarium exhibits' ambient noise levels under normal operating conditions.

## **B. NEARSHORE BAY VERSUS THE TWO SMALLER EXHIBITS**

The next comparative analysis is between the Monterey Bay Habitats Exhibit, the Kelp Forrest Exhibit and the nearshore bay location (Figure 6.2). Again, the estimated curves use shipping densities of 0 and 0.5 and wind speeds of 2 and 10 m/s.

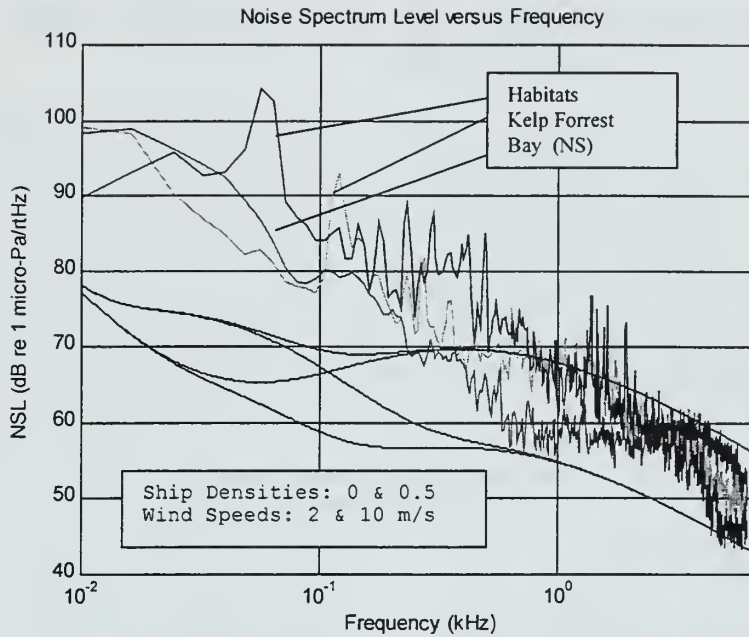

**Figure 6.2.** Observed 12-Hz-average-band NSL versus frequency of the Habitats and Kelp Forrest Exhibit and the Nearshore Bay location. The estimated NSLs are for  $D=0$  and  $0.5$ , and  $w=2$  and  $10$  m/s. Total broadband (0-6.4 kHz) NLs are: Habitats, 118 dB; KFE, 112 dB; Bay(NS), 113 dB re 1  $\mu$ Pa.

In contrast to the large differences in noise levels observed between the OBW and the offshore bay, these spectra are remarkably similar. With the exception of the peaks at 60 and 120 Hz in the aquarium exhibits, the noise level differences across the entire frequency range are generally only 5-10 dB; both aquarium exhibits are actually quieter than the bay between 4 and 7 kHz. Again, this is the region dominated by the surface (wind and waves) effects, which are only present in the bay.

Recall that, other than the volume of water, the primary difference between the three aquarium exhibits is their proximity to the pump machinery room and the circulated seawater flow rates. This leads one to believe that these mechanical noise sources are the largest contributors to ambient noise in the exhibits. To verify this, a correlation analysis of pump vibration and



underwater acoustic noise would have to be performed. This is suggested for follow-on work.

Figure 6.3 is a plot of the same data shown in Figure 6.2, restricted to the frequency range of 1-6.4 kHz. The fact that the Habitats and the KFE have very similar NSLs at frequencies above 1 kHz and that they have similar seawater circulation flow rates and are equidistant from the pump machinery room reinforces the previous conclusion.

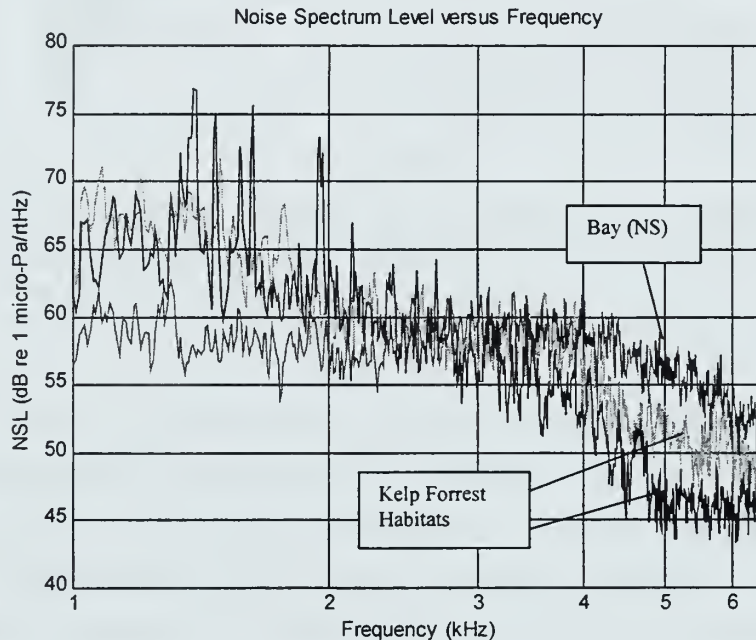

**Figure 6.3.** Observed 12-Hz-average-band NSL versus frequency for the Habitats and Kelp Forrest Exhibit and for the Nearshore Bay location. Total broadband (0-6.4 kHz) NLs are: Habitats, 118 dB; KFE, 112 dB; Bay(NS), 113 dB re 1  $\mu$ Pa.

## VII. CONCLUSIONS AND RECOMMENDATIONS

### A. SUMMARY

There are a number of known contributors of ambient noise in the Monterey Bay Aquarium. These include, but are not limited to, some of the following: seawater circulation pump machinery; seawater circulation flow noise; the ambient air temperature controlling equipment, including fans and air conditioning; service elevators and passageways; industrial and retail noise from nearby businesses; and finally, noise from the human factor, including visitors as well as aquarium personnel.

While it would be almost impossible to determine to exactly what extent these various contributors effect the ambient noise levels, this investigation has attempted to point out some of the more probable and most significant factors.

Table 7.1 is a summary of the broadband noise levels for all locations and conditions reported in this investigation.

**Table 7.1** Measured broadband (0-6.4 kHz) noise level (NL) for the reported locations and conditions.

Location	Condition	NL (0-6.4 kHz) (dB re 1µPa)
Bay, Offshore	Wind=7 m/s	116
Bay, Nearshore	Wind=1-2 m/s	113
Kelp Forest Exhibit	Pumps/waves/sprinklers on	112
Habitats	Pumps only on	118
Outer Bay Waters	Pumps/fans on, bubbles on	124
Outer Bay Waters	Pumps/fans on, bubbles off	125
Outer Bay Waters	Pumps on, fans/bubbles off	121
Outer Bay Waters	Total power out	110

Figure 7.1 is a comparison of the NSLs of the Kelp Forest, the Habitats and the Outer Bay Waters exhibit with all equipment operating as normal. Also plotted are the estimated deep-water NSLs using the values of  $D = 0$  and  $0.5$ , and  $w = 2$  and  $10$  m/s.

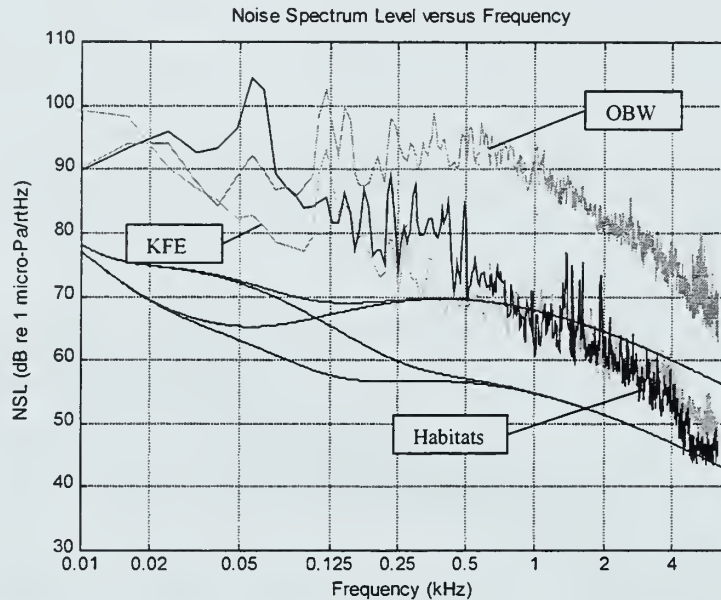

**Figure 7.1.** Observed 12-Hz-band-average NSL for the OBW, KFE and Habitats exhibits. The estimated NSLs are for  $w=2$  and  $10$  m/s. Total broadband NLs are: OBW, 124 dB; Habitats, 118 dB; KFE, 112 dB (re  $1 \mu\text{Pa}$ ).

Figure 7.2 is a similar comparison of the Nearshore and Offshore bay locations. Also plotted are the same estimated deep-water NSLs as in Figure 7.1, for comparison.

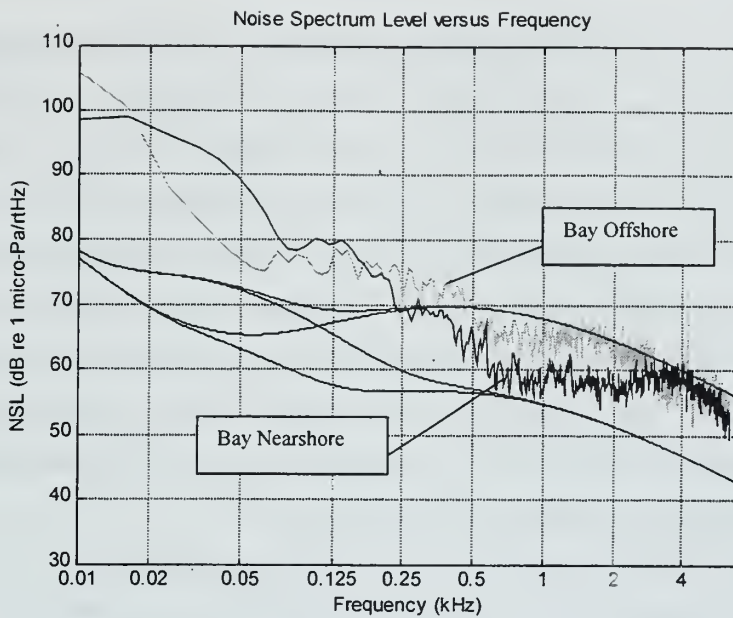

**Figure 7.2.** Observed 12-Hz-band-average NSL for the Nearshore and Offshore bay. The estimated NSLs are for  $w=2$  and 10 m/s. Total broadband NLs are 113 dB and 116 dB (re 1  $\mu$ Pa) for Nearshore and Offshore, respectively

The results of the comparative analysis between the offshore bay location and the aquarium's largest exhibit as it normally operates were expected. The aquarium was significantly louder across the entire observed spectrum. When this same offshore data was compared with the aquarium in its power-out state, the NSLs were much more similar, especially for frequencies below 1 kHz. Above 1 kHz, the bay actually had a higher noise level. As mentioned in Chapter II, noise in the frequency regime between 1 kHz and 100 kHz is dominated primarily by the surface agitation effects such as wind and surface waves. These factors, of course, were not present in the case of the aquarium. Prominent, narrow, power-line-related noise peaks at frequencies of 60 and 120 Hz were observed in both measurements of the Outer Bay Waters exhibit (normal operation and power out). The fact that, for frequencies

greater than 1 kHz, the bay was quieter than the normally-operating aquarium but louder than the power-out aquarium, leads one to conclude that the sea-state and the wind speed are indeed the main contributors of ambient noise in the bay in this frequency range. The only conclusion that can be drawn thus far about the noise levels in the OBW is still the obvious one, that the aquarium is much louder with the power on. This is no doubt the result of the mechanical equipment, predominantly air conditioning and seawater circulation pumps, operated close-by.

The Kelp Forest and Habitats exhibits follow similar trends when compared to the nearshore bay location. The primary exception is that the magnitude of the difference between the NSLs of the smaller tanks and the nearshore bay is significantly less than that of the large tank and the offshore bay. The noise spectrum level of the OBW, although similar in general characteristics such as the slope and falloff in the higher frequencies, is significantly greater across the entire spectrum.

The Habitats and Kelp Forest Exhibits share many similarities. Their volumes are roughly equivalent as well as their seawater circulation flow rates and their proximity to the pump machinery room. Also very similar are their observed noise spectrum levels. With respect to these criteria, they are not, however, very similar to the Outer Bay Waters exhibit. The OBW contains almost five times the volume of water, has a seawater circulation flow rate almost three times greater and is located very near the pump machinery. This leads one to conclude that these factors are the prime contributors to the higher noise levels in the OBW exhibit.

## **B. SUGGESTIONS FOR FURTHER INVESTIGATION**

Clearly, machinery noise is the most prominent contributor to the underwater ambient noise observed in the Monterey Bay Aquarium exhibits. Exactly how much each piece of equipment (pumps, fans, etc.) contributes to the total noise level in an exhibit could be determined by a correlation analysis of machinery vibration and underwater acoustic noise. This follow-on research could help to precisely identify the prominent noise sources and their specific paths of transmission into the aquarium exhibits.

With the results of this suggested follow-on analysis, mitigating measures might be taken to effectively reduce the levels of noise in the exhibits.





# APPENDIX A. EQUIPMENT SPECIFICATIONS

## DT-276 HYDROPHONE SPECIFICATIONS AND FREQUENCY RESPONSE

Type: Piezoelectric hollow cylinder

Active element diameter: 6.5 cm

Active element length: 14 cm

Nominal low frequency sensitivity: -187 dB re 1 V/ $\mu$ Pa

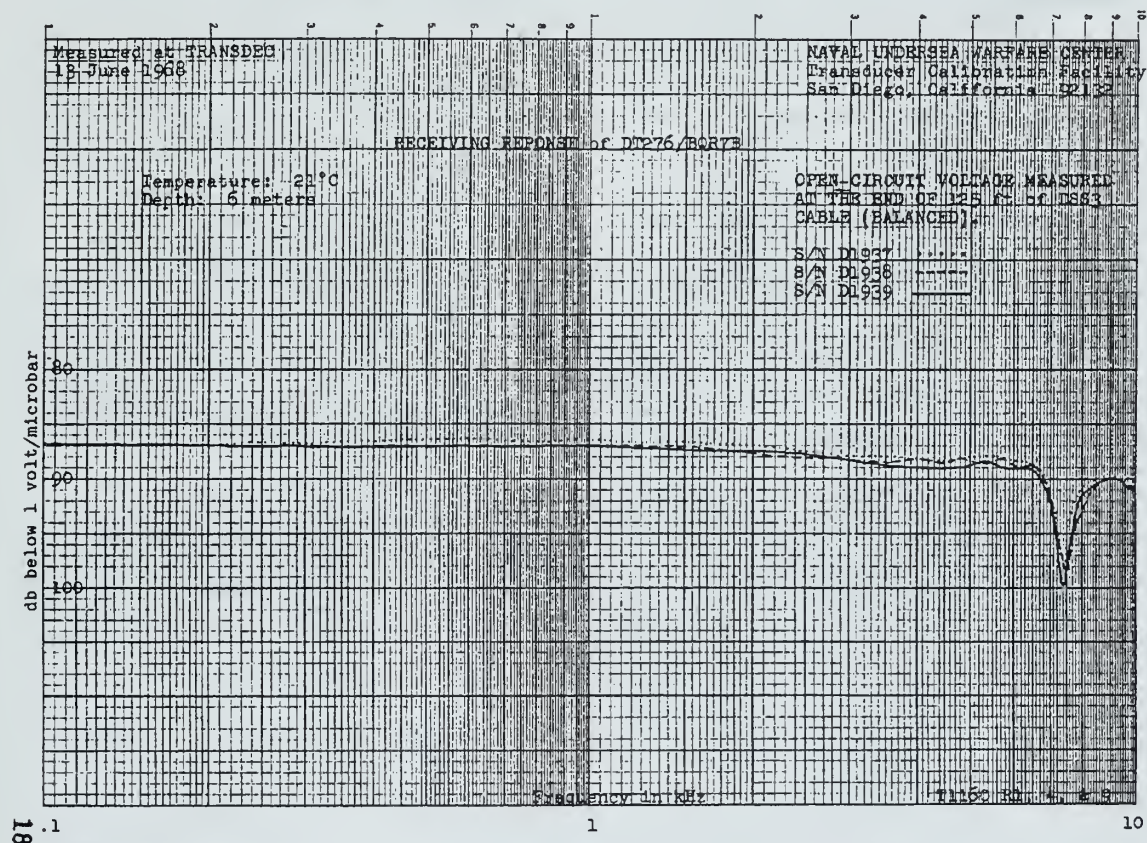

# TASCAM DIGITAL AUDIO TAPE RECORDER, MODEL DA-P1

## Specifications

---

**Format :** Rotary head digital audio tape deck  
**Record Time :** 120 minutes (with 120-min tape)  
**Fast Winding Time :** Approx. 60 seconds  
**Tape Speed :** 8.15 mm/sec. (12.225 mm/sec. during play)

**Quantization :** 16-bit linear  
**Error Correction Method :** Octuple error correction  
**Drum Speed :** 2,000 rpm  
**Sampling Rates :**

48 kHz recording (digital/analog), play  
44.1 kHz recording (digital/analog), play  
32 kHz recording (digital only), play

**Channel :** 2 channels  
**Frequency Response :** 20 Hz to 20 kHz,  $\pm 0.5$  dB (44.1/48 kHz) (LINE)

**S/N :** Better than 90 dB (LINE)

**Dynamic Range :** Better than 90 dB (LINE)

**Total Harmonic Distortion :** Better than 0.007%, 1 kHz (LINE)

**Channel Separation :** Better than 85 dB (1 kHz)

**Wow and Flutter :** Unmeasurable (less than  $\pm 0.001\%$ )

### Analog I/O

#### MIC/LINE IN (XLR-3-31 x 2)

##### MIC

**Nominal level :** -60 dBm (0.8 mV)

**PAD :** 20 dB

**Input impedance :** 2.5 kohms, balanced

##### LINE

**Nominal level :** +4 dBm (1.2 V)

**Input impedance :** 10 kohms, balanced

#### LINE IN (RCA x 2)

**Nominal level :** -10 dBv (0.3 V)

**Input impedance :** 35 kohms, unbalanced

#### LINE OUT (RCA x2) :

**Nominal level :** -10 dBv (0.3 V)(10-kohm load)

**Output impedance :** 500 ohms, unbalanced

#### PHONES (1/4" Jack x 1)

**Max. output level :** 15 mW + 15 mW (32 ohms)

### Digital I/O

**IN (RCA x 1) :** IEC 958 TYPE II (S/PDIF)

**OUT (RCA x 1) :** IEC 958 TYPE II (S/PDIF)

**Power Supply :** 2-way (AC adaptor PS-D1 and Ni-Cd battery BP-D1 (7.2 V, 1.4 Ah))

**U.S.A./Canada :** 120 VAC, 60 Hz

**Europe :** 230 VAC, 50 Hz

**U.K./Australia :** 240 VAC, 50 Hz

### Power Consumption :

13W (with PS-D1, during OPERATE)

15W (with PS-D1, during CHARGE)

**Battery Charging Time :** Within approx. 2.5 hours

**Battery Life :** Approx. 120 minutes (continuous recording, PHANTOM OFF), approx. 100 minutes (continuous recording, PHANTOM ON, (2 mA x 2)), Approx. 180 minutes (stop)

**Dimensions (WxHxD) :** 258 x 54 x 188 mm (10-3/16" x 2-1/8" x 7-3/8")

**Weight :** 1.2 kg (2-10/16 lbs) (excluding battery (240 g))

**Supplied Accessories :** AC adaptor/battery charger (PS-D1), Ni-Cd battery (BP-D1), and Carrying belt

○ *In these specifications, 0 dBv is referenced to 1 Volt, and 0 dBm is referenced to 0.775 Vrms. Actual voltage levels are also given in parenthesis (0.316 V for -10 dBv rounded off to 0.3 V).*

○ *Changes in specifications and features may be made without notice or obligation.*

ITHACO 1201 LOW-NOISE PREAMPLIFIER SPECIFICATIONS

IPS-134 **MODEL 1201**  
**LOW NOISE**  
**PROGRAMMABLE PREAMPLIFIER** **ITHACO**  
 735 WEST CLINTON STREET, ITHACA, NEW YORK 14850, PHONE 607-277-7648, TW 607-255-9372

**SPECIFICATIONS**

INPUT IMPEDANCE	DC Coupled: Greater than 1 gigohm (1000 megohms); typically 5 gigohms (5000 megohms). AC Coupled: 100 megohms																					
INPUT CURRENT	Less than 10pA, either input; less than 5pA difference (offset) current.																					
INPUT FREQUENCY RESPONSE	< 0.008 Hz (AC coupled)																					
DC STABILITY (vs. Temperature)	6 $\mu$ V/ $^{\circ}$ C max, referred to input; 300 $\mu$ V/ $^{\circ}$ C max, referred to output.																					
DC STABILITY (vs. Time)	20 $\mu$ V/24 hr, non-cumulative, maximum, after 1/2 hour warmup.																					
MAXIMUM INPUT, COMMON MODE	10 volts, pk-pk, minimum.																					
MAXIMUM INPUT, DIFFERENTIAL OR SINGLE-ENDED	$\pm$ 750mV (gains of X10 - X100) $\pm$ 75mV (gains of X200 - X10K)																					
COMMON MODE REJECTION (Minimum)	<table border="1"> <thead> <tr> <th>Frequency</th> <th>Gain &gt; 200</th> <th>Gain &lt; 200</th> </tr> </thead> <tbody> <tr> <td>DC - 100 Hz</td> <td>125 dB</td> <td>115 dB</td> </tr> <tr> <td>1 kHz</td> <td>105 dB</td> <td>95 dB</td> </tr> <tr> <td>10 kHz</td> <td>85 dB</td> <td>75 dB</td> </tr> <tr> <td>100 kHz</td> <td>65 dB</td> <td>55 dB</td> </tr> <tr> <td>200 kHz</td> <td>55 dB</td> <td>45 dB</td> </tr> <tr> <td>400 kHz</td> <td>50 dB</td> <td>40 dB</td> </tr> </tbody> </table>	Frequency	Gain > 200	Gain < 200	DC - 100 Hz	125 dB	115 dB	1 kHz	105 dB	95 dB	10 kHz	85 dB	75 dB	100 kHz	65 dB	55 dB	200 kHz	55 dB	45 dB	400 kHz	50 dB	40 dB
Frequency	Gain > 200	Gain < 200																				
DC - 100 Hz	125 dB	115 dB																				
1 kHz	105 dB	95 dB																				
10 kHz	85 dB	75 dB																				
100 kHz	65 dB	55 dB																				
200 kHz	55 dB	45 dB																				
400 kHz	50 dB	40 dB																				
GAIN	X10 to X10,000 in a 1-2-5-10 sequence; front panel potentiometer provides continuous gain to X25,000.																					
GAIN ACCURACY	Better than 1% when vernier is in CAL position.																					
GAIN STABILITY	Better than 0.03%/ $^{\circ}$ C.																					
DISTORTION	Typically less than 0.01%.																					
FREQUENCY RESPONSE	DC Coupled: DC to 400 kHz (-3 dB) with low pass switch in MAX position. AC Coupled: 0.008 Hz to 400 kHz (-3 dB) with low pass switch in MAX position.																					
HIGH PASS FILTER (low frequency rolloff)	Switch-selectable from DC and 0.03 Hz to 3 kHz, in a 1-3-10 sequence.																					
LOW PASS FILTER (high frequency rolloff)	Switch-selectable from 3 Hz to 300 kHz and MAX in a 1-3-10 sequence; bandwidth in MAX position is 400 kHz minimum.																					
NOISE FIGURE	Less than 0.4 dB at 10 Hz, with a 1 megohm source impedance. Less than 0.04 dB at 1 kHz, with a 1 megohm source impedance.																					
NOISE	Less than 15 nV per Hz <sup>-1/2</sup> at 10 Hz. Less than 7 nV per Hz <sup>-1/2</sup> at 1 kHz.																					
OUTPUTS	Four outputs (BNC) as follows: a) 600 $\Omega$ outputs (2). b) Lo-Z output (to 25 mA, 50 $\Omega$ ). c) Unity-gain (X1) output.																					
MAXIMUM OUTPUT VOLTAGE (battery operation)	a) 600 $\Omega$ outputs: 12 volts pk-pk, minimum. b) Lo-Z output: 10 volts pk-pk minimum, up to 25 mA. c) Unity-gain (X1) output: 1.3 volts pk-pk minimum, up to 7 mA.																					
MAXIMUM OUTPUT VOLTAGE (line operation)	a) 600 $\Omega$ outputs: 20 volts pk-pk, minimum. b) Lo-Z output: 18 volts pk-pk minimum, up to 25 mA. c) Unity-gain (X1) output: 2 volts pk-pk, minimum, up to 7 mA.																					
GATED OPERATION	Preamplifier may be gated with external input (rear panel BNC). Any waveform type, including TTL or contact closure, is permissible. Minimum duration (pulse) is 20 $\mu$ sec.																					
REMOTE PROGRAMMING	Option (user-installable) inputs permit remote control of gain (from X10 to X10,000 in a 1-2-5-10 sequence), overload recovery and gating. Gain and/or overload may be latched. Device select function line allows multiplexing several Model 1201 Preamplifiers. Option outputs indicate remote operation, incorrect gain command, gain status, gain un-CAL, overload, low pass filter status and high pass filter status. Format is BCD-coded.																					





# APPENDIX B. AQUARIUM SCHEMATICS

## THE OUTER BAY WATERS EXHIBIT

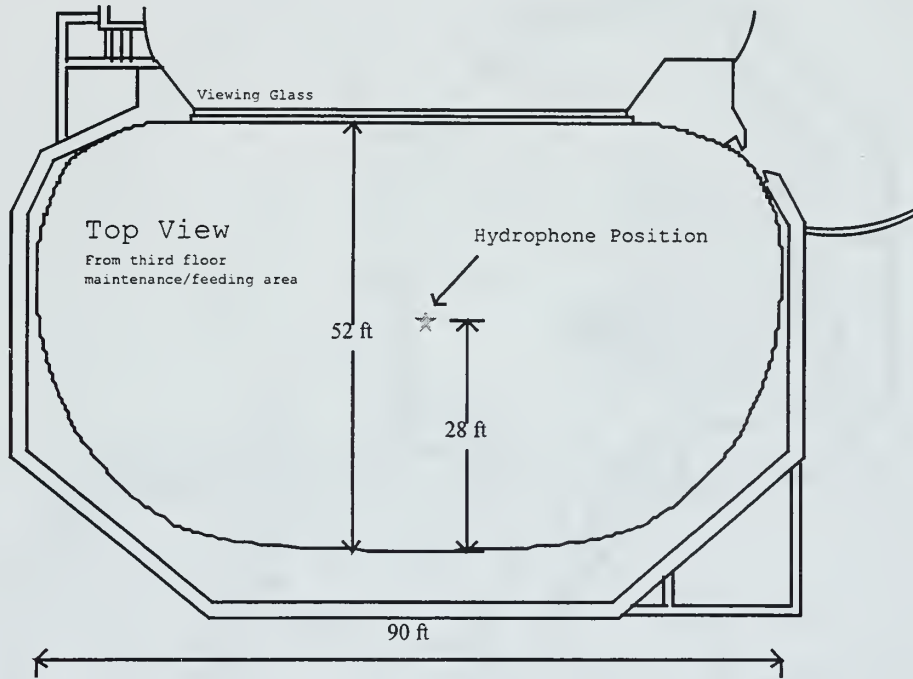

**Side View**

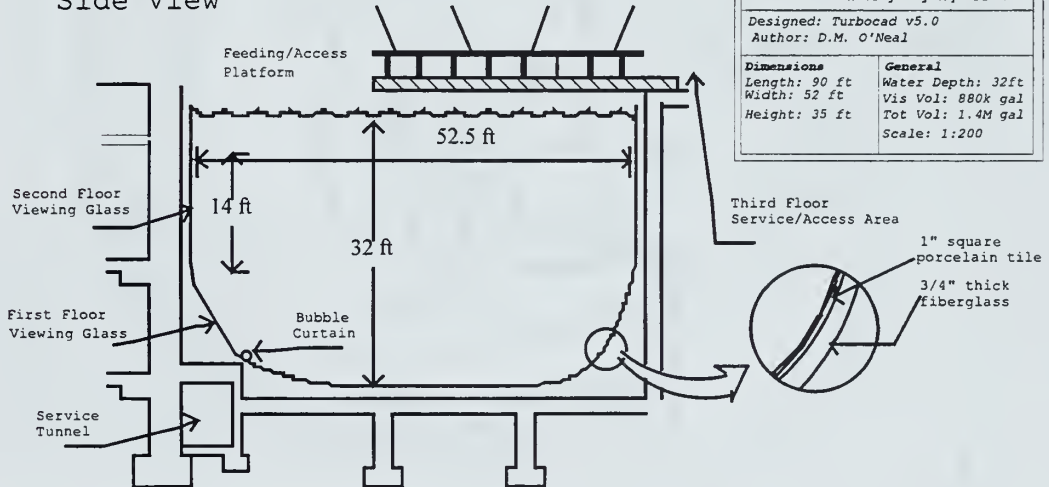

Drawing Number: aq001	
Title: Outer Bay Waters	
Location: Monterey Bay Aquarium	
Designed: Turbocad v5.0	
Author: D.M. O'Neal	
<b>Dimensions</b>	<b>General</b>
Length: 90 ft	Water Depth: 32ft
Width: 52 ft	Vis Vol: 880k gal
Height: 35 ft	Tot Vol: 1.4M gal
	Scale: 1:200

# THE MONTEREY BAY HABITATS EXHIBIT

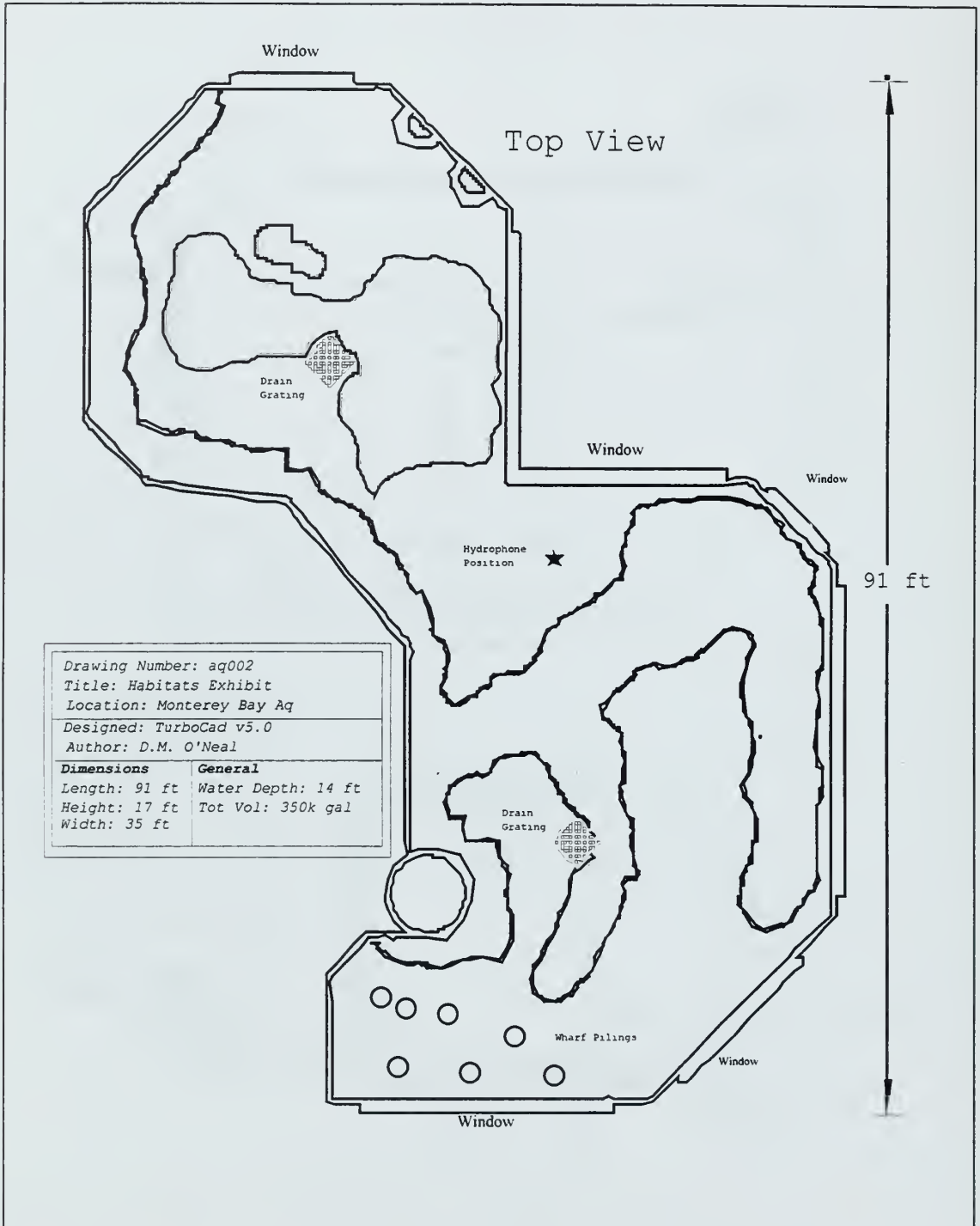



# THE KELP FOREST EXHIBIT

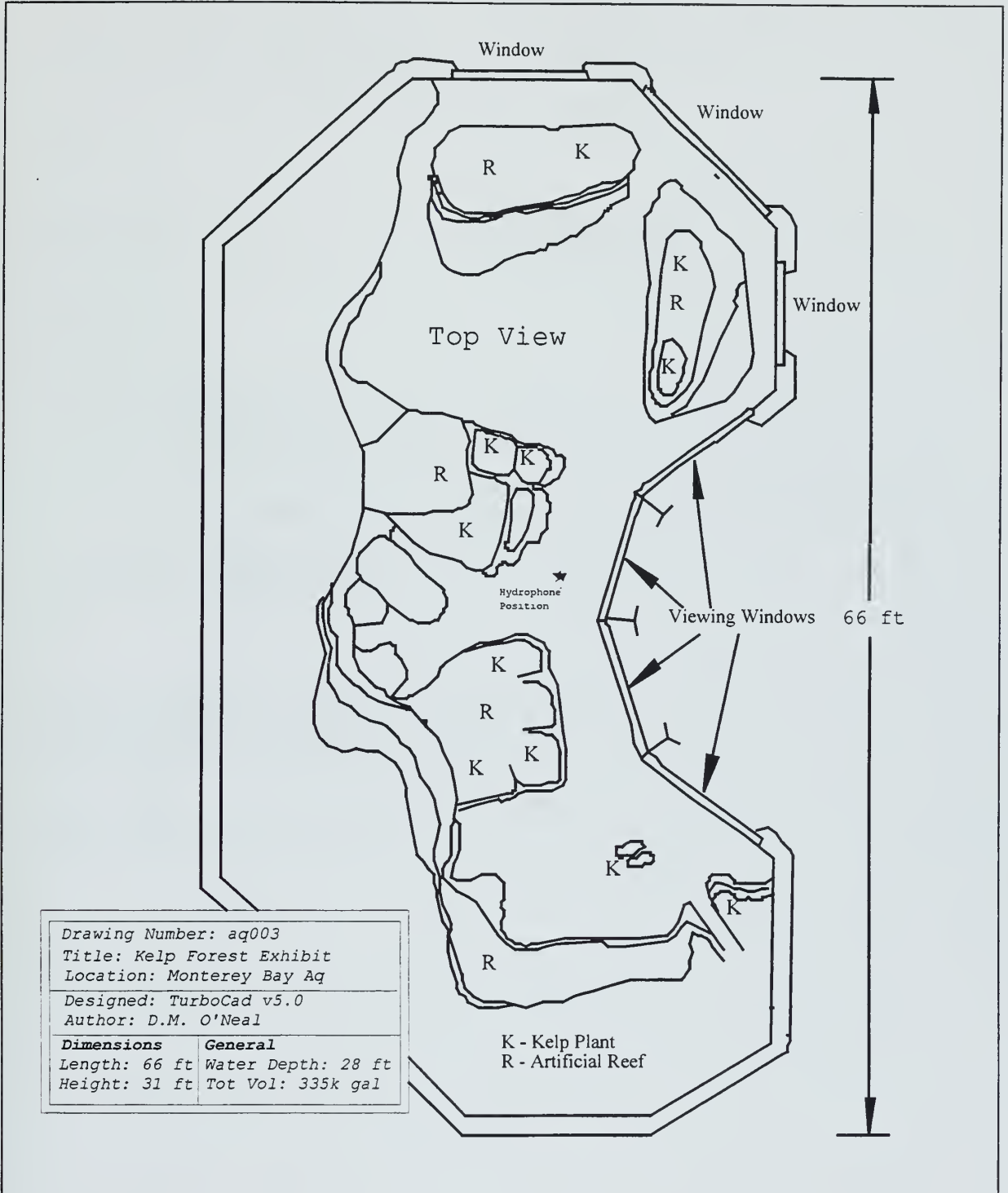

<i>Drawing Number: aq003</i>	
<i>Title: Kelp Forest Exhibit</i>	
<i>Location: Monterey Bay Aq</i>	
<i>Designed: TurboCad v5.0</i>	
<i>Author: D.M. O'Neal</i>	
<b>Dimensions</b>	<b>General</b>
Length: 66 ft	Water Depth: 28 ft
Height: 31 ft	Tot Vol: 335k gal

K - Kelp Plant  
R - Artificial Reef



## APPENDIX C. MATLAB PROGRAMMING CODE

```
% Sample MATLAB Programming code for generating the estimated
% Noise Spectrum Levels in the sea due to the various
% sources from 1 Hz to 1000 kHz.
% Produces plot of Coates' work (Figure 2.2)[3].

clear all;
format short;

Dvec=[0 0.5 1.0];           % shipping (0 to 1)
wvec=[0 5 10 15];          % wind speeds (m/s)
f=logspace(-3, 3, 1000);    % frequency (in kHz)

for j=1:3;
    D=Dvec(j);
for i=1:4;
    w=wvec(i);
    NSL1=17-30*log10(f);
    NSL2=40+20*(D-0.5)+26*log10(f)-60*log10(f+0.03);
    NSL3=50+7.5*sqrt(w)+20*log10(f)-40*log10(f+0.4);
    NSL4=-15+20*log10(f);

NSL=10*log10(10.^(NSL1/10)+10.^(NSL2/10)+10.^(NSL3/10)+10.^(NSL4/10));

    semilogx(f,NSL,'-');
    axis([10^-3 1000 0 110]);
    grid on; hold on;
end
end

gtext('Wind speeds (m/s)');
gtext('0');gtext('5');gtext('10');gtext('15');
gtext('Shipping density');
gtext('0');gtext('0.5');gtext('1');

title('Ambient Noise from Various Sources');
xlabel('Frequency (kHz)');
ylabel('NSL (dB re 1 micro-Pa)');
```

```

% Sample MATLAB Programming code for plotting narrowband NSLs of
% various locations and generating the estimated NSLs from
% specific wind speeds and sea states.
% This code produces a plot of the Monterey Bay (Offshore) versus
% the Outer Bay Waters (Normal operating condition).

clear all;
format short;

% ***** LOAD RECORDED DATA HERE *****

load d:\matt\bay\n51001.mat; y1=4.*(y/2); % bay-offshore
load d:\matt\aq\n81401.mat; y3=y/2; % obw, normal op

x2=(0:0.008:6.4)';

db8hz_y1=10*log10(y1);
dblhz_y1=db8hz_y1-3-3-3-1.79;
psdy1=10.^(dblhz_y1/10);
sply1=10*log10(trapz(x2(1:length(x2))*1000,psdy1(1:length(x2))))

db8hz_y3=10*log10(y3);
dblhz_y3=db8hz_y3-3-3-3-1.79;
psdy3=10.^(dblhz_y3/10);
sply3=10*log10(trapz(x2(1:length(x2))*1000,psdy3(1:length(x2))))

semilogx(x2,dblhz_y3,'b',x2,dblhz_y1,'g');
axis([10^-3 10 20 120]);
grid on; hold on;

set(gca,'gridlinestyle','-')
set(gca,'minorgridlinestyle','-')
set(gca,'linewidth',3)

% ***** GENERATE THE ESTIMATED NSLs BELOW *****

Dvec=[0 0.5]; % shipping (0 to 1)
wvec=[2 10]; % wind speeds (m/s)
f=logspace(-3, 1, 1000); % frequency (in kHz)

for j=1:length(Dvec);
    D=Dvec(j);
    for i=1:length(wvec);
        w=wvec(i);
        NSL1=17-30*log10(f);
        NSL2=40+20*(D-0.5)+26*log10(f)-60*log10(f+0.03);
        NSL3=50+7.5*sqrt(w)+20*log10(f)-40*log10(f+0.4);
        NSL4=-15+20*log10(f);

        NSL=10*log10(10.^(NSL1/10)+10.^(NSL2/10)+10.^(NSL3/10)+10.^(NSL4/10));

        semilogx(f,NSL,'-');
        axis([10^-2 10^(.85) 30 110]);
        grid on; hold on;
    end
end

title('Noise Spectrum Level versus Frequency');
xlabel('Frequency (kHz)');ylabel('NSL (dB re 1 micro-Pa/rtHz)');

```

```

% Sample MATLAB Programming code for plotting one-third-octave
% broadband NSLs of various locations.
% This specific code produces a plot of the Monterey Bay (Offshore)
% versus the Monterey Bay (Nearshore).

clear all; format short;

% ***** LOAD SPECIFIC DATA HERE *****

load d:\matt\bay\071004.mat; y1_cor=y/2; % bay, nearshore
load d:\matt\bay\053118.mat; y2_cor=y/2; % bay, offshore

y1=10*log10(y1_cor); y2=10*log10(y2_cor);

% DEFINE THE STANDARD CENTER BANDS FOR 1/3 OCTAVE ANALYSIS
freq_real=[10 12.5 16 20 25 31.5 40 50 63 80 100 125 160 ...
           200 250 315 400 500 630 800 1000 1250 1600 ...
           2000 2500 3150 4000 5000 6300 8000]';

freq_log=log10(freq_real);
x=logspace(1,3.90309,30);

semilogx(freq_real,y1,'-square'); hold on;
semilogx(freq_real,y2,'-o');

set(gca,'gridlinestyle','-')
set(gca,'minorgridlinestyle','-')
set(gca,'xtick',[16 31.5 63 125 250 500 1000 2000 4000 8000]);

grid on;

title('One-Third-Octave-Band Spectrum Level')
ylabel('One-Third-Octave Level (dB)')
xlabel('Frequency (Hz)')
legend('Nearshore','Offshore');

```





## LIST OF REFERENCES

1. Caruthers, J.W., *Fundamentals of Marine Acoustics*, Elsevier Scientific Publishing Company, 1977.
2. Kinsler, L.E., A.R. Frey, A.B. Coppens, J.V. Sanders, *Fundamentals of Acoustics*, 3<sup>rd</sup> ed., John Wiley & Sons, 1982.
3. Urick, R.J., *Principles of Underwater Sound*, 3<sup>rd</sup> ed., McGraw-Hill Book Company, 1983.
4. Etter, P.C., *Underwater Acoustic Modeling*, Elsevier Applied Science, 1991.
5. Carey, W.M., J.W. Fitzgerald, "Low Frequency Noise From Breaking Waves", *Natural Physical Sources of Underwater Sound*, pp. 277-304, 1993.
6. Medwin, H., C.S. Clay, *Fundamentals of Acoustical Oceanography*, Academic Press, 1998.
7. Coates, R.F.W., *Underwater Acoustic Systems*, John Wiley and Sons, 1989.
8. Wenz, G.M., "Acoustic Ambient Noise in the Ocean: Spectra and Sources", *Journal of the Acoustic Society of America*, Vol. 34, Nr. 12, pp. 1936-1956, 1962.
9. Map created using the TIGER Mapping Service, U.S. Census Bureau, URL: [<http://tiger.census.gov>].



## INITIAL DISTRIBUTION LIST

1. Defense Technical Information Center.....2  
8725 John J. Kingman Rd, STE 0944  
Ft. Belvior, Virginia 22060-6218
2. Dudley Knox Library.....2  
Naval Postgraduate School  
411 Dyer Rd.  
Monterey, California 93943-5101
3. Professor Steven R. Baker, Code PH/Ba.....2  
Department of Physics  
Naval Postgraduate School  
Monterey, California 93943-5000
4. Professor Thomas G. Muir, Code PH/Mt.....1  
Department of Physics  
Naval Postgraduate School  
Monterey, California 93943-5000
5. Randy Hamilton, Alan Young.....2  
Monterey Bay Aquarium  
886 Cannery Row  
Monterey, California 93940-1085
6. Dr. William Spitzer.....1  
New England Aquarium  
Central Wharf  
Boston, Massachusetts 02110
7. Commander Warren Hintz (USN, ret).....1  
3534 Mesa Court  
Carmel, California 93921
8. Lieutenant D.M. O'Neal.....1  
P.O. Box 1814  
Dunlap, Tennessee 37327





6 483NPG TH 2844  
10/99 22527-200 FILE









DUDLEY KNOX LIBRARY



3 2768 00366787 4